

Model 855B RF / Multi-Channel Microwave Signal Generator



Features

- Ultra-Low Phase Noise
- 25 μ s Fast Switching
- Phase Coherent Switching Option
- 2 to 4 Phase Coherent Outputs
- USB, LAN, GPIB Interfaces

Applications

- Radar Simulation
- Quantum Computing
- High Volume Automated Testing
- Phased Array Antenna / Beamforming
- Electronic Warfare



Model 855B Datasheet v1.66

300 kHz to 40 GHz RF / Multi-Channel Microwave Signal Generator

DEFINITIONS

- The specifications in the following pages describe the warranted performance of the instrument for 23 ± 5 °C after a 30-minute warm-up period

Typical: Expected mean values, not warranted performance

Min and max: Parameter range that is guaranteed by product design, and/or production tested. Warranted performance specifications include guard-bands to account for the expected statistical performance distribution, measurement uncertainties, and changes in performance due to environmental conditions.

INTRODUCTION

- **A compact, 300 kHz to 6, 12, 20, 33, or 40 GHz ultra-low phase noise, 25 μ s phase coherent switching, multi-channel signal generator**

The Model 855B is a phase-coherent, multi-channel, high output power, ultra-fast switching and ultra-low phase noise signal generator with a frequency range from 300 kHz to 6, 12, 20, 33 or 40 GHz. It is ideally suited for a wide range of applications, where good signal quality, accurate and wide output power ranges, and very stable phase coherence among all channels are required. Excellent phase noise is combined with good spurious, harmonic rejection and optionally leading-edge switching speed of 25 μ s.

A high-stability OCXO reference provides excellent frequency accuracy and stability. The generator accepts a wide range of external references including the commonly used 10 and 100 MHz for higher phase synchronization, and a flexible reference choice in the range of 1-250 MHz for those applications with customer- or system-specific reference frequencies. Moreover, the Model 855B features a pair of BNC-specific high-frequency CLK ports (one input and one output) that enables excellent phase synchronization among the outputs from multiple Model 855B modules.

The Model 855B comes in a standard 19 inch 1U (up to 4 channels) rack-mountable module form. It can be intuitively controlled by a PC based GUI Software. Moreover, the instrument offers various communication interfaces like USB, LAN or GPIB. Each interface allows for easy and fast communication using SCPI 1999 command set. Remote control of the instrument can be quickly attained from any host system. A customer-supplied application programming interface (API) or programming examples for Matlab, Labview, C++ and other commercially available tools make the control implementation very straightforward.

SPECIFICATIONS

Signal Specifications

PARAMETER	MIN	TYPICAL	MAX	NOTE
Frequency Range	300 kHz		6 GHz	855B-6
	300 kHz		12 GHz	855B-12
	300 kHz		20 GHz	855B-20
	300 kHz		33 GHz	855B-33
	300 kHz		40 GHz	855B-40
Resolution		<0.001 Hz		
Phase Adjustment Range	0 deg		360 deg	individually adjustable per channel
Phase Resolution		0.1 deg		
Switching Speed		1.5 ms		after SCPI command received
CW Mode		500 μs		
Sweep / List Mode		500 μs		
		25 μs		Option FS
SSB Phase noise at 1 GHz (max output power; ALC Off)				see plots/tables
at 10 Hz from carrier		-87 dBc/Hz		Option LN
at 1 kHz from carrier		-100 dBc/Hz		
at 100 kHz from carrier		-130 dBc/Hz		
		-145 dBc/Hz		
Output Power Level 855B-6/12/20/33/40G				
< 100 MHz	-30 dBm		+20 dBm	
100 MHz to 6GHz	-30 dBm		+25 dBm	
6 GHz to 18 GHz	-30 dBm		+23 dBm	
18 GHz to 20 GHz	-30 dBm		+20 dBm	
20 GHz to 40 GHz	-30 dBm		+18 dBm	
Output Power Level 855B-6/12/20G				Option PE4
10 MHz to 6 GHz	-90 dBm		+22 dBm	
6 GHz to 12GHz	-90 dBm		+21 dBm	
12 GHz to 15 GHz	-90 dBm		+18 dBm	
15 GHz to 20 GHz	-90 dBm		+16 dBm	
> 20 GHz	-90 dBm		+12 dBm	
Output Power Level 855B-33/40G				Option PE4
10 MHz to 12 GHz	-60 dBm		+23 dBm	
12 GHz to 20 GHz	-60 dBm		+21 dBm	
20 GHz to 33 GHz	-60 dBm		+ 16 dBm	
> 33 GHz	-60 dBm		+ 15 dBm	
Power Resolution		0.01 dB		
Thermal Drift		0.015 dB/°C		
Power Level Uncertainty				
< 6 GHz		0.25 dB	0.8 dB	-15 to +15 dBm
			1.2 dB	-60 to -15 dBm or > 15 dBm
6 to 12.75 GHz		0.3 dB	0.9 dB	-15 to +15 dBm
			1.3 dB	-60 to -15 dBm or > 15 dBm
12.75 to 26 GHz		0.3 dB	1.0 dB	-15 to +15 dBm
			1.6 dB	-60 to -15 dBm or > 15 dBm
26 to 40 GHz		0.4 dB	1.2 dB	-15 to +15 dBm
			1.7 dB	-50 to -15 dBm or > 15 dBm
		4 dB		< -60 dBm
Reverse Power Protection				
DC Voltage			±10 V	
RF Power			26 dBm	

PARAMETER	MIN	TYPICAL	MAX	NOTE
Output impedance		50 Ohms		
VSWR		1.3 1.6 1.9	1.5 1.8 2.2	< 15 GHz 15 to 35 GHz > 35 GHz
Harmonics				at +5 dBm output power
10 to 200 MHz		-30 dBc	-20 dBc	
200 MHz to 6 GHz		-40 dBc	-30 dBc	
6.5 to 12.75 GHz		-35 dBc	-30 dBc	
12.75 to 20 GHz		-45 dBc	-30 dBc	
20 to 40 GHz		-40 dBc	-30 dBc	
Sub-Harmonics				
< 5GHz		-75 dBc	-70 dBc	
5-20 GHz		-70 dBc	-65 dBc	
> 20GHz		-55 dBc		
Non-Harmonic Spurious				> 10 kHz offset
< 1.2 GHz		-90 dBc	-85 dBc	
1.2 to 2.5 GHz		-92 dBc	-88 dBc	
2.5 to 5 GHz		-87 dBc	-82 dBc	
5 to 10 GHz		-80 dBc	-75 dBc	
10 to 20 GHz		-75 dBc	-70 dBc	
20 to 40 GHz		-67 dBc		
Channel to Channel Performance				
Isolation				
< 3 GHz	90 dB			
3 to 6.5 GHz	70 dB	80 dB		
> 6 GHz		> 60 dB		
300 kHz to 40 GHz	80 dB	> 90 dB		Option HI, see plot
Relative Phase Stability				See plot
Between channels		0.096 ps		3 mrad at 5 GHz over 5 hours
Between synchronized Modules		0.160 ps		5 mrad at 5 GHz over 5 hours
Phase-Coherent Switching				
Phase mismatch at outputs		15 ps		



Modulation Capabilities

PARAMETER	MIN	TYPICAL	MAX	NOTE
Pulse Modulation				
Modulation Source		Internal/ External		
External input amplitude	TTL			
Pulse rise/fall time		10 ns		
On/off ratio		90 dB 80 dB 75 dB	80 dB 70 dB	Pout > +10 dBm, f < 6.5 GHz 6.5 to 18 GHz > 18 GHz
Pulse overshoot			10%	
Pulse delay		20 ns		
Pulse polarity		Normal, inverse		selectable
Internal pulse generator				
Repetition frequency (PRF)	0.1 Hz		50 MHz	= 1/T
Duty cycle	1 % to 99 % in 1% steps			within specified minimum pulse width
Pulse Pattern Modulation & Staggered PRF				using internal pattern generator
Pulse width	10 ns		20 s	
Programmable pattern length	2		65536	
Duty cycle	0.05%		99.95%	
Pulse width resolution		5 ns		
Pulse period (T) accuracy		0.00005xT+ 3ns		
Pulse width accuracy		0.00005xT+ 5ns		
Pulse jitter		2 ns	5 ns	
Polarity		selectable		
Amplitude Modulation				
Option MOD				
Modulation Source		Internal		
Modulation Depth	0%		90%	
Deviation accuracy		2%	4%	1 kHz rate, 30% depth
Deviation resolution		1%		
Distortion (THD)			1%	1 kHz rate, 30% depth
Modulation rate	0.1 Hz		20 kHz	
Modulation waveforms	Sine			
Frequency Modulation				
Option MOD				
Modulation source		Internal		
Maximum Frequency deviation (peak)	N · 200 MHz			< 1.25 GHz (N=1) 1.25 GHz to 2.5 GHz (N=0.125) 2.5 GHz to 5 GHz (N=0.25) 5 GHz to 10 GHz (N=0.5) 10 GHz to 20 GHz (N=1) 20 GHz to 40 GHz (N=2)
Deviation accuracy		0.50%	2%	
Distortion (THD)		< 1 %		1 kHz rate, 10 kHz deviation
Modulation rate	0.1 Hz		80 kHz	
Modulation waveforms	Sine			

PARAMETER	MIN	TYPICAL	MAX	NOTE
Phase Modulation				Option MOD
Modulation Source		Internal		
Phase deviation (peak)	0		$300 \cdot N \cdot \text{rad}$	
Deviation accuracy		0.50%	2%	
Modulation rate	0.1 Hz		80 kHz	
Modulation waveforms		Sine		
Distortion (THD)		< 1%		1 kHz rate & N x rad deviation

Sweeping Capability

PARAMETER	MIN	TYPICAL	MAX	NOTE
Sweep Parameters	Frequency, power, phase, list			
Sweep type	Linear, logarithmic, random			
Step time (t_{step})	500 μ s 25 μ s 50 μ s		19998 s 19998 s 19998 s	Option FS (2 sync channels) Option FS (3 or 4 sync channels)
Dwell time (t_{dwell})	15 μ s		9999 s	
Off time (t_{off})	15 μ s		9999 s	
Time resolution		5 ns		
Timing delay (τ_{de})		50 ns		
Transient time (τ_{inv})			15 μ s	
Timing accuracy per point		5 ns		

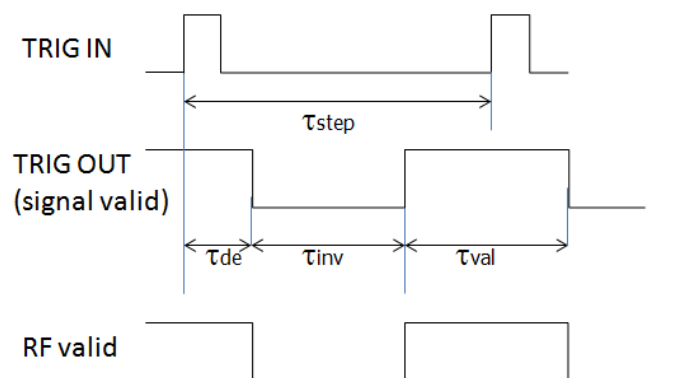



Frequency Reference

PARAMETER	MIN	TYPICAL	MAX	NOTE
Internal Reference Frequency		100 MHz 10 MHz		Option LN
Temperature stability 0 to 50 degC			±100 ppb ±20 ppb	Option LN
Aging 1st year			1000 ppb 30 ppb 20 ppb	Option LN Option LN+
Aging per day			0.5 ppb	after 30 days operations
Warm-up time		5 min		
Output of internal reference		10 MHz 100 MHz		REF OUT port, selectable
Output of High Frequency Clock		3 GHz		CLK OUT port high phase synchronous mode
Output power		0 dBm 9 dBm		10 MHz, 3 GHz 100 MHz
Output impedance		50 Ohms		
Bypass Internal Reference Input		100 MHz 1 GHz		
Phase Lock to External Reference	1	10 MHz integer MHz	250	REF IN port Option VREF
High Frequency Clock Input (Bypass Internal Reference)		3 GHz		CLK IN port high phase synchronous mode
Reference input level				
10 MHz or 1-250 MHz or 3 GHz	-5 dBm	0 dBm	+10 dBm	
100 MHz or 1 GHz	5 dBm		+13 dBm	
Lock Range				
10 MHz or 1-250 MHz			±1.5 ppm	
100 MHz			100 ppm	
Reference Input Impedance		50 Ohms		



Multi-Purpose Output (TRIG OUT)

Output is TRIG OUT at rear panel

PARAMETER	MIN	TYPICAL	MAX	NOTE
MULTIFUNCTION GENERATOR				
sine, triangle, square wave				
Frequency range	1 Hz 1 Hz		3 MHz 1 MHz 50 kHz	sine triangle square
Frequency resolution		0.1 Hz		
Output voltage amplitude peak-peak	10 mV	5V	2 V	Sine, triangle Square (CMOS output)
Harmonic Distortion		1 %		< 100 kHz, 1 Vpp
Output impedance		50 Ω CMOS		Sine, triangle square wave

VIDEO OUTPUT (of internal pulse modulator)

Output		CMOS		
Period	20 ns		50 s	
Pulse Width	10 ns		50 s	
RF delay		10 ns		

TRIGGER OUT Synchronization mode for multiple sources

Modes	Trigger on sweep start Trigger on each point Signal Valid	Option FS
-------	-----------------------------------------------------------------	-----------



Trigger (TRIG IN)

PARAMETER	MIN	TYPICAL	MAX	NOTE
Trigger Types		Continuous Single (point) Gated Gated direction		
Trigger Source		External Bus (LAN, USB)		
Trigger Modes		Continuous free run Trigger and run Reset and run		
Trigger latency		5 ns		
Trigger uncertainty		10 ns		
External trigger delay	50 ns		40 s	settable
External delay resolution		5 ns		
Trigger Modulo	1		255	execute only on Nth trigger event
Trigger Polarity		Rising Falling		

PERFORMANCE CURVES

Phase Noise with and without Option LN (at 1 GHz and 20 dBm output power)

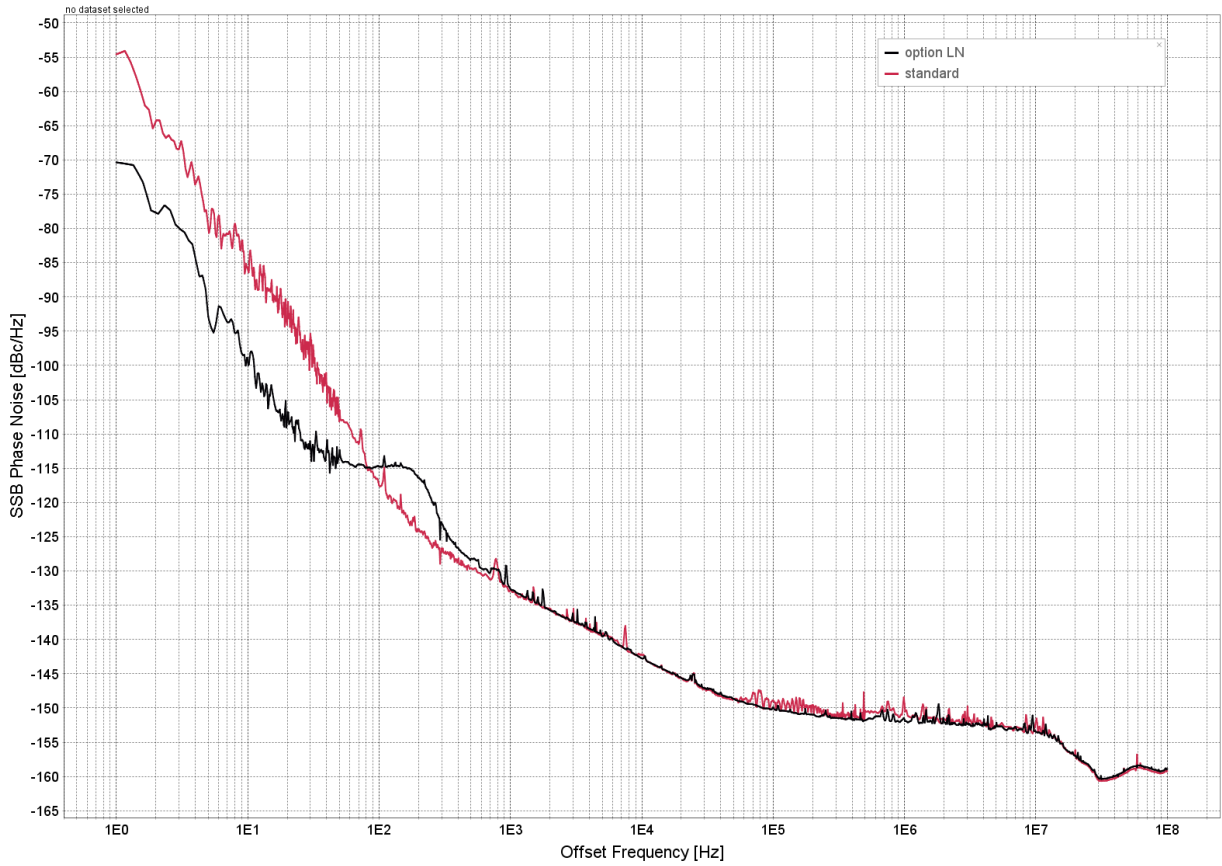

(at 6 GHz and 20 dBm output power)

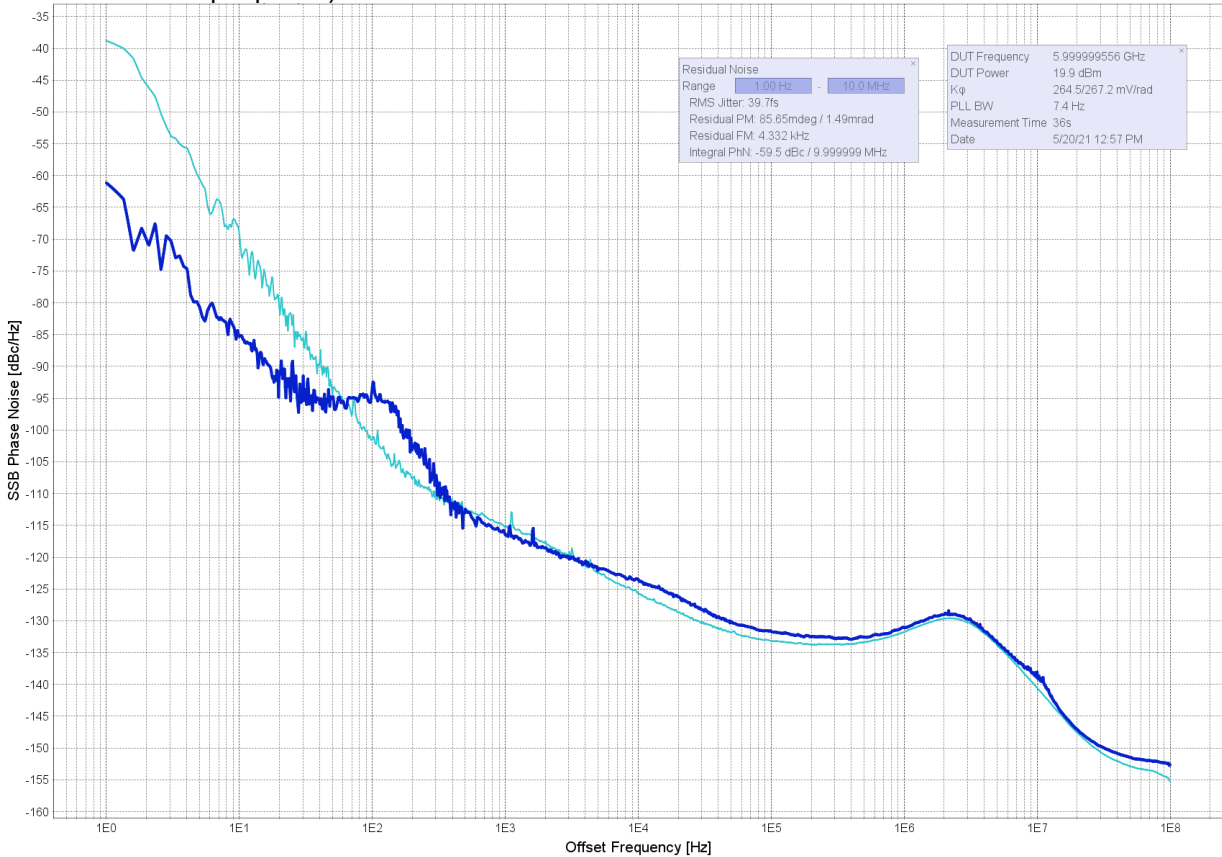

Phase Noise without Option LN (at max. output power)

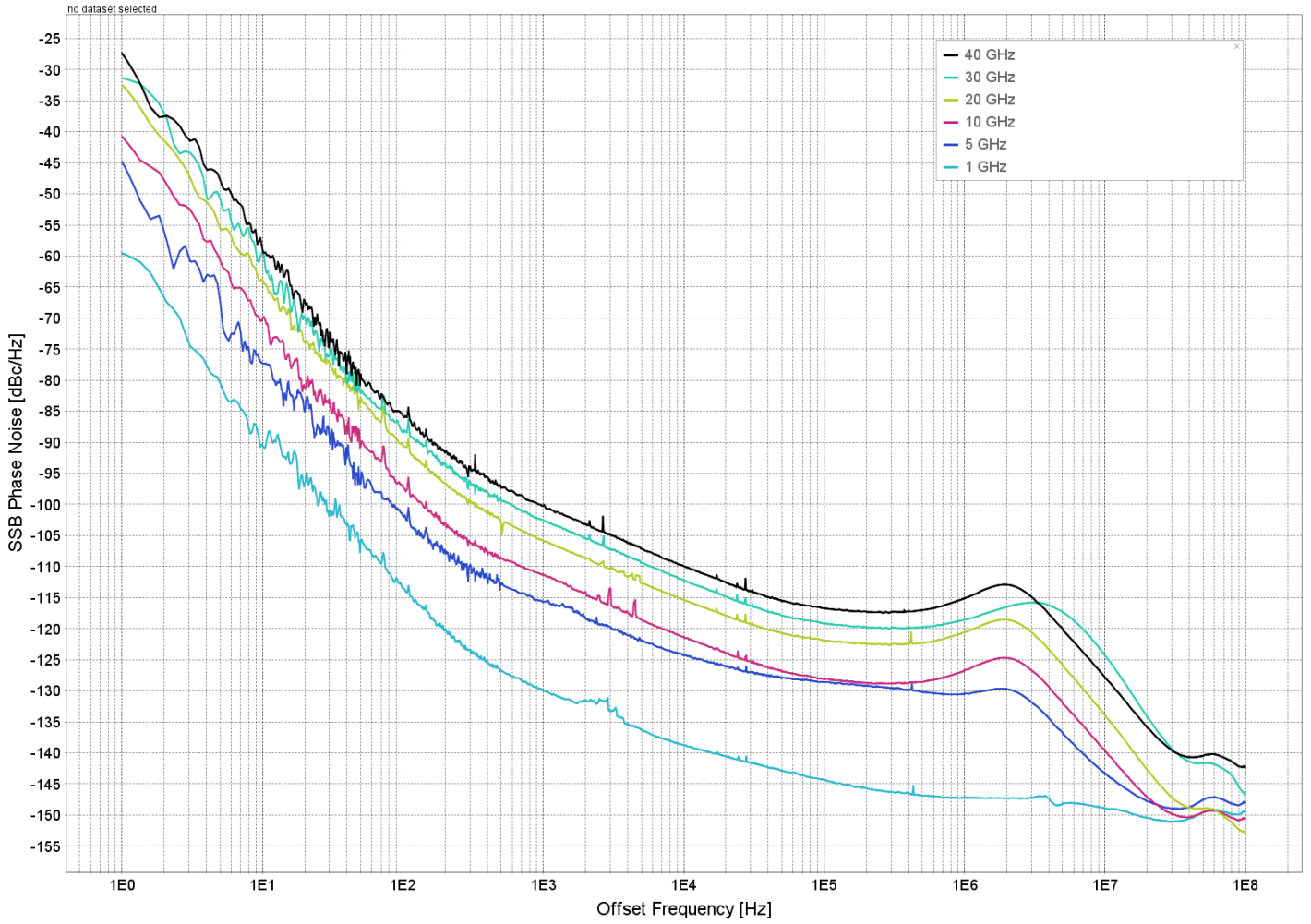

Maximum Output Power 855B-20 with and without Option PE4

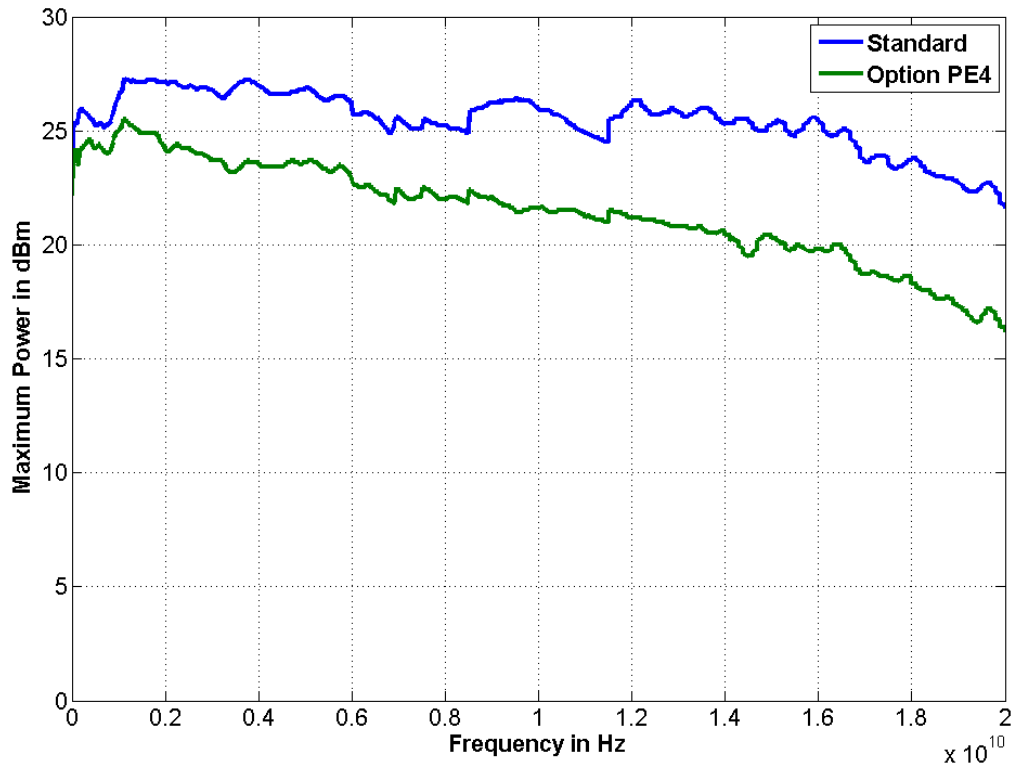

Maximum Output Power 855B-40 with and without Option PE4

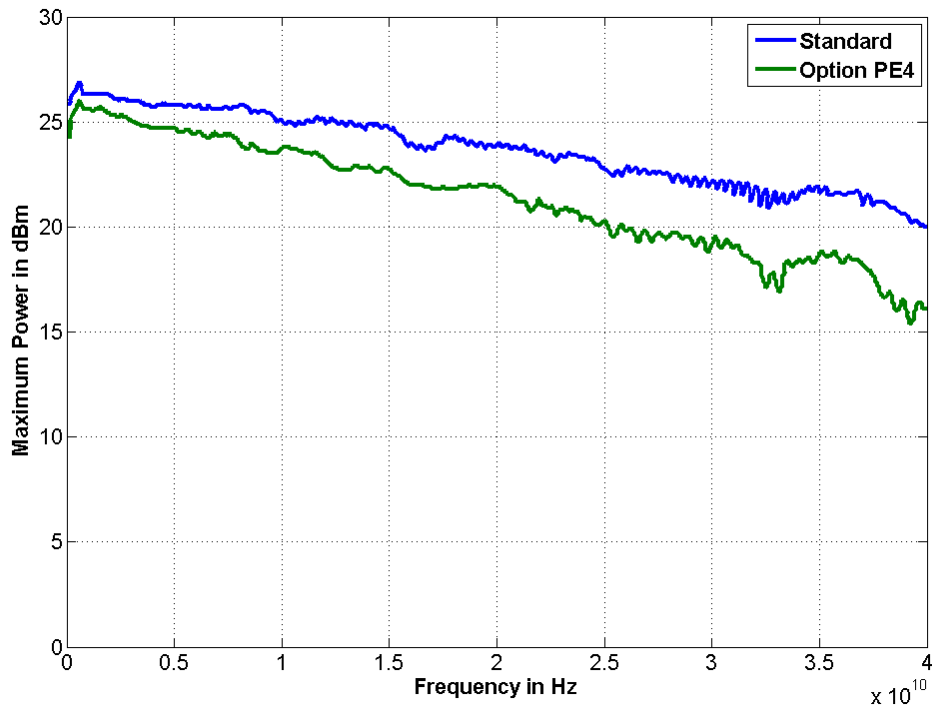

Low Frequency Response 855B-20 (100 kHz to 100 MHz)

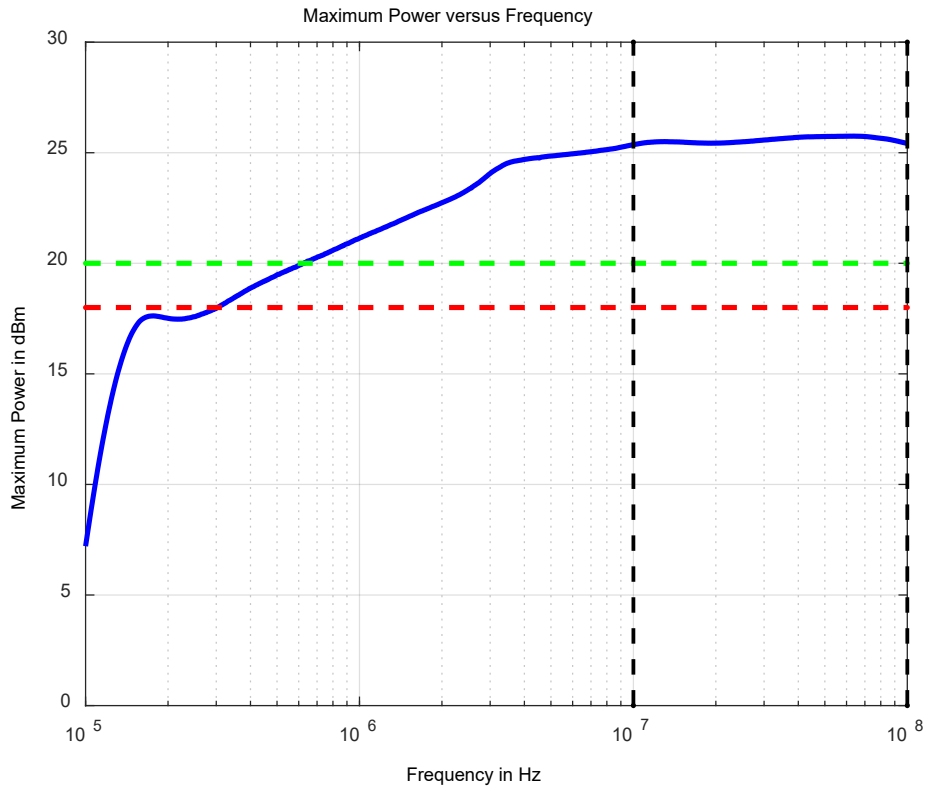

Level Error (300 kHz to 40 GHz, 855B-40)

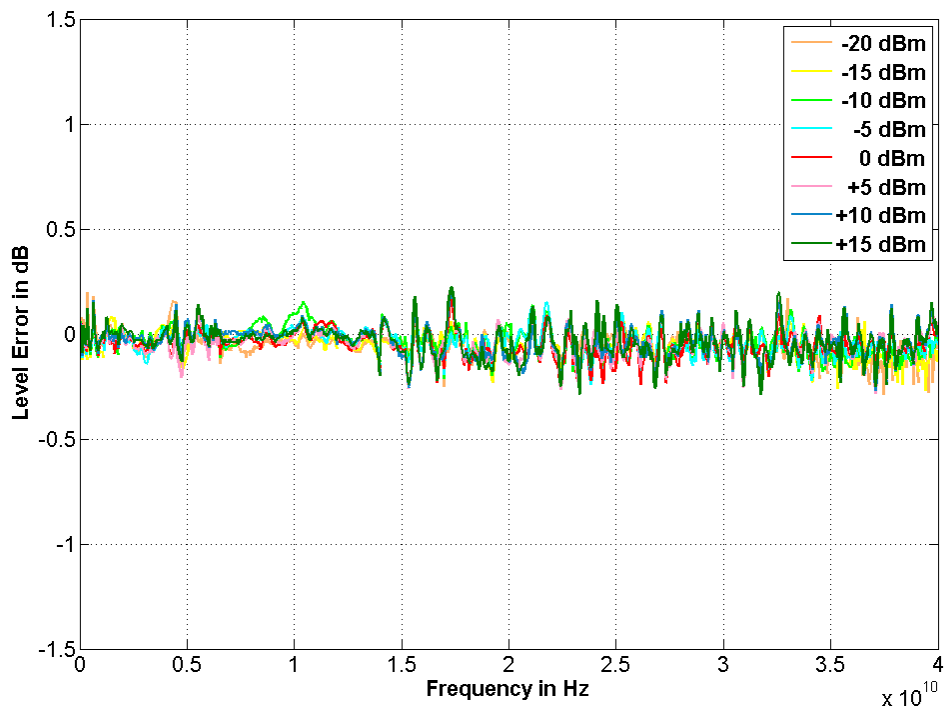

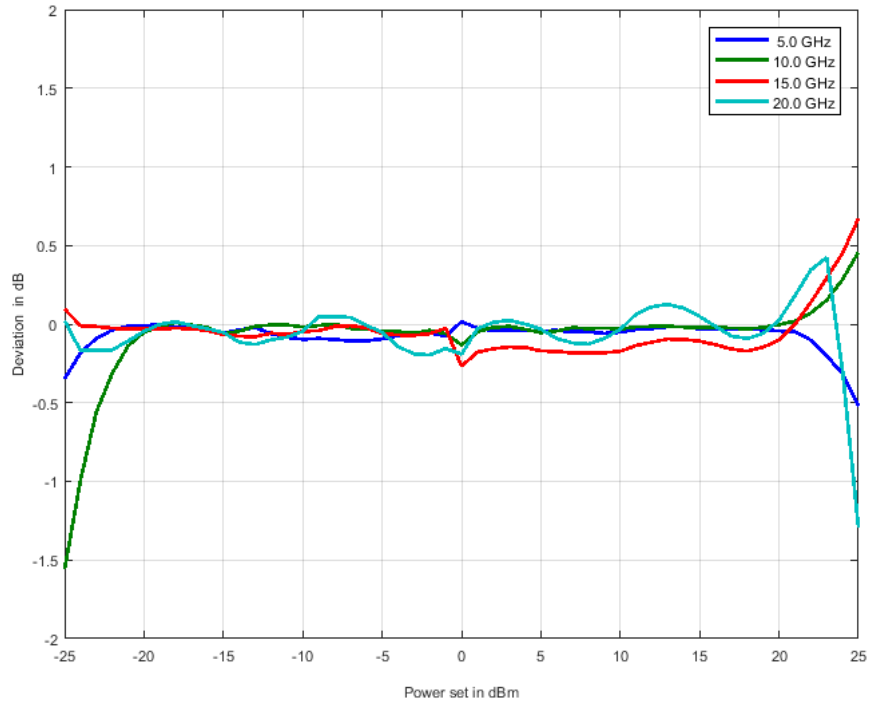

 **Channel-to-Channel Isolation with Option HI**

(Channel under test: Channel 1, frequency f , power 10 dBm
 Channel 2, 3 and 4: frequency $f + 9$ MHz, power 10 dBm
 Measurement made on channel 1 at frequency $f + 9$ MHz)

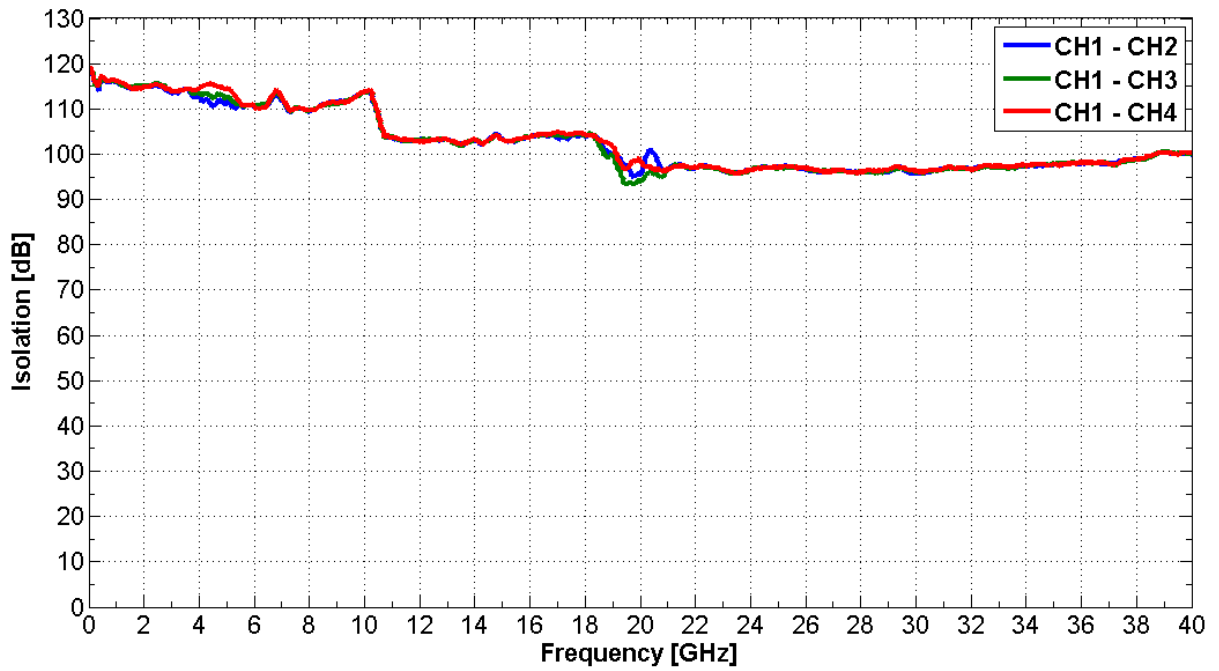

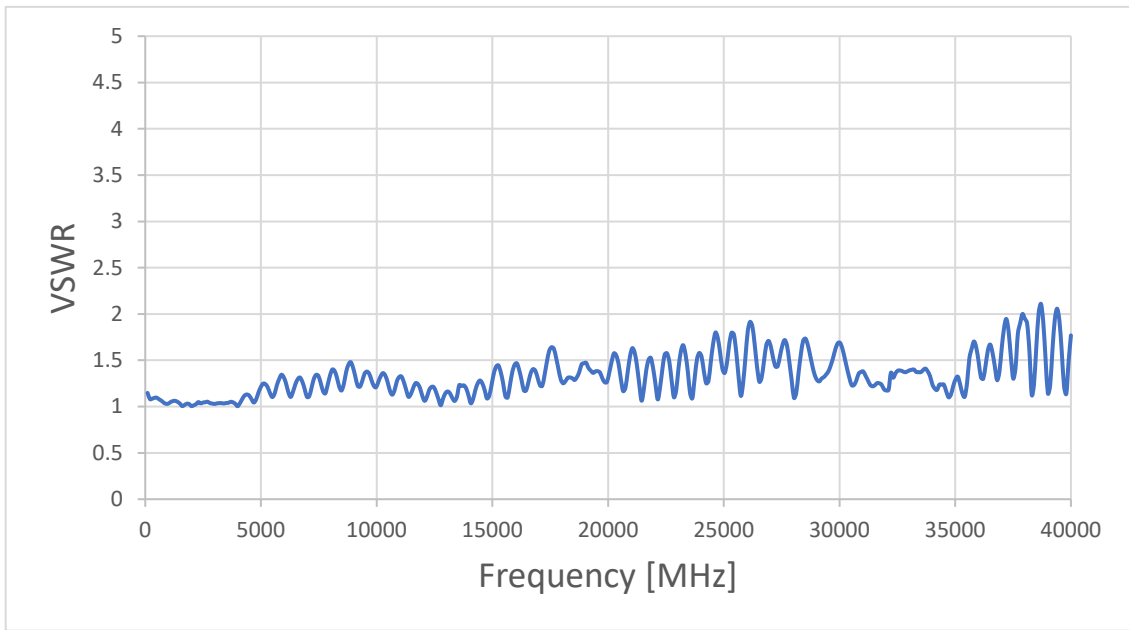

Channel-to-Channel Phase Stability under Different Test Conditions

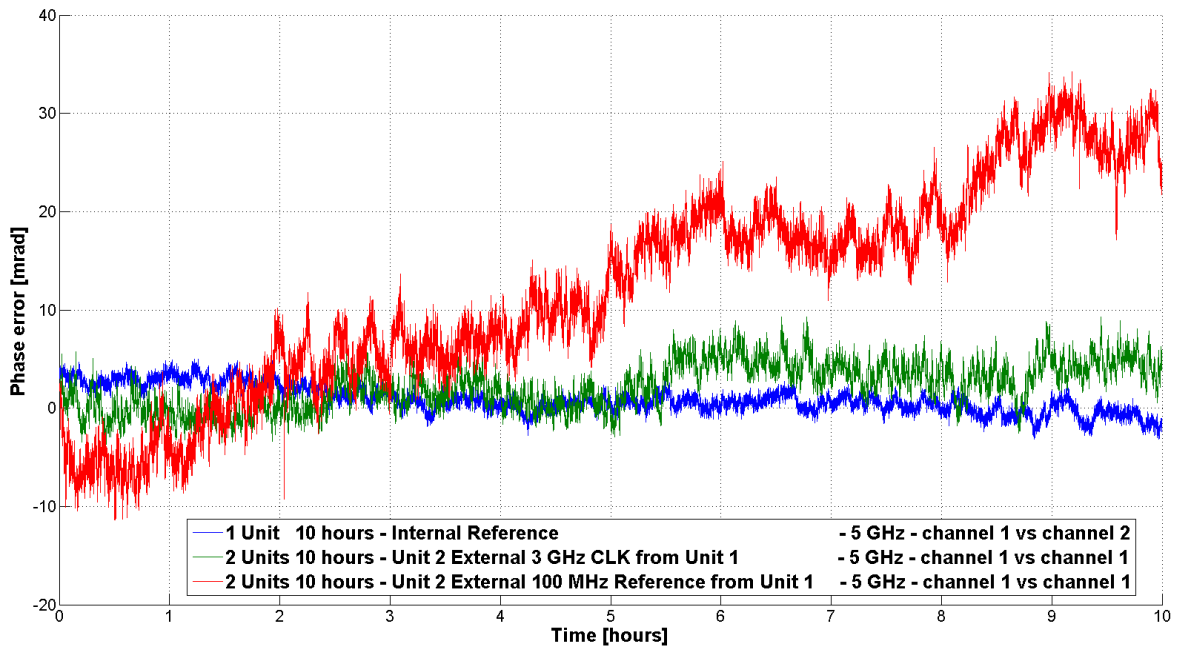

Connectors (Front)

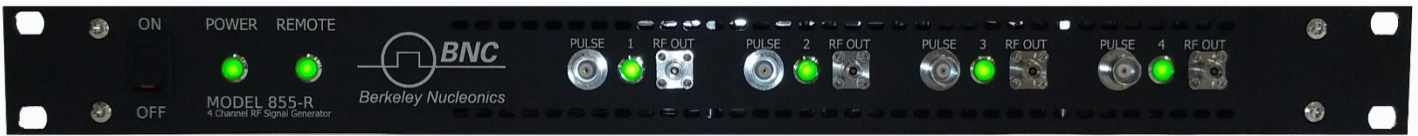

- RF outputs:
- 855B-33, 40G: K (2.92 mm) female
- 855B-6, 12G, 20G: SMA female
- External pulse modulation inputs: BNC female
- DC power switch

Connectors (Rear)



- Unit-to-unit synchronization signal input (SYNC IN): SMA female
- Unit-to-unit synchronization signal output (SYNC OUT): SMA female
- High Stability Reference input (CLK IN, 3 GHz): SMA female
- High Stability Reference output (CLK OUT, 3 GHz): SMA female
- Trigger output: BNC female
- Trigger input: BNC female
- Reference output (REF OUT): BNC female
- Reference input (REF IN): BNC female
- GPIB: IEEE-488.2, 1987 with listen and talk (optional)
- USB 2.0 device
- LAN connection: RJ-45
- FUSE (3.15 A)
- 100-240 VAC power plug



High Isolation Casing 19" 1U (Option HI, rack mount kit included)



High Isolation Casing 19" 1U (Option HI using the rack mount kit)



ORDERING INFORMATION



Host Model No.	Product	Description
Model 855B	855B-6-2	2-channel 300 kHz to 6 GHz ultra-low phase noise, fast switching signal generator, 19" 1U rack-mount module
Model 855B	855B-6-3	3-channel 300 kHz to 6 GHz ultra-low phase noise, fast switching signal generator, 19" 1U rack-mount module
Model 855B	855B-6-4	4-channel 300 kHz to 6 GHz ultra-low phase noise, fast switching signal generator, 19" 1U rack-mount module
Model 855B	855B-12-2	2-channel 300 kHz to 12 GHz ultra-low phase noise, fast switching signal generator, 19" 1U rack-mount module
Model 855B	855B-12-3	3-channel 300 kHz to 12 GHz ultra-low phase noise, fast switching signal generator, 19" 1U rack-mount module
Model 855B	855B-12-4	4-channel 300 kHz to 12 GHz ultra-low phase noise, fast switching signal generator, 19" 1U rack-mount module
Model 855B	855B-20-2	2-channel 300 kHz to 20 GHz ultra-low phase noise, fast switching signal generator, 19" 1U rack-mount module
Model 855B	855B-20-3	3-channel 300 kHz to 20 GHz ultra-low phase noise, fast switching signal generator, 19" 1U rack-mount module
Model 855B	855B-20-4	4-channel 300 kHz to 20 GHz ultra-low phase noise, fast switching signal generator, 19" 1U rack-mount module
Model 855B	855B-33-2	2-channel 300 kHz to 33 GHz ultra-low phase noise, fast switching signal generator, 19" 1U rack-mount module
Model 855B	855B-33-3	3-channel 300 kHz to 33 GHz ultra-low phase noise, fast switching signal generator, 19" 1U rack-mount module
Model 855B	855B-33-4	4-channel 300 kHz to 33 GHz ultra-low phase noise, fast switching signal generator, 19" 1U rack-mount module
Model 855B	855B-40-2	2-channel 300 kHz to 40 GHz ultra-low phase noise, fast switching signal generator, 19" 1U rack-mount module
Model 855B	855B-40-3	3-channel 300 kHz to 40 GHz ultra-low phase noise, fast switching signal generator, 19" 1U rack-mount module
Model 855B	855B-40-4	4-channel 300 kHz to 40 GHz ultra-low phase noise, fast switching signal generator, 19" 1U rack-mount module
Model 855B	option LN	Enhanced close in phase noise and frequency stability
Model 855B	option LN+	Option LN with improved long term frequency stability
Model 855B	option PHS	Phase coherent switching
Model 855B	option FS	Ultra-fast switching speed
Model 855B	option VREF	Flexible external reference frequency support in range 1 to 250 MHz
Model 855B	option MOD	Amplitude, Frequency, Phase modulations added.
855B-6/12G	option PE4-12	Electrical step attenuator (6 & 12 GHz version)
855B-20	option PE4-20	Electrical step attenuator (20 GHz version)
855B-33/40G	option PE4-40	Electrical step attenuator (33 & 40 GHz version)
Model 855B	option GPIB	GPIB interface

Model 855B	Option HI	High Isolation 19" 1U casing (highly improved channel-to-channel isolation)
-------------------	------------------	-----------------------------------------------------------------------------

GENERAL CHARACTERISTICS

Remote programming interfaces:

Ethernet 100BaseT LAN interface
USB 2.0 device
GPIB (IEEE-488.2,1987) with listen and talk (Option GPIB)
Control Language SCPI Version 1999.0

Power requirements: 100 - 240 VAC, 50 or 60 Hz, 160W maximum (80W + 20W per channel)

Environmental: Levels similar to MIL-PRF-28800F Class 3/4

Environmental stress Samples of this product have been type tested to be robust against the environmental stresses of storage, transportation, and end-use; those stresses to temperature, humidity, shock, vibration, altitude, and power line conditions.

Operating temperature range 32 to 104 F (0 to 40 °C)

Storage temperature range -40 to 158 F (-40 to 70 °C)

Operating and storage altitude up to 15,000 feet (4600 m)



Safety / EMC comply with applicable Safety and EMC regulations and directives.

Weight:

Standard casing: ≤ 22.05 lbs (10.0 kg) net

HI casing: ≤ 26.45 lbs (12.0 kg) net

Dimensions: 19" 1U enclosure

855B-6/12/20G: 1.7 in H x 16.8 in W x 18.1 in L [43 mm H x 426 mm W x 460 mm L]

855B-33/40G: 1.7 in H x 16.8 in W x 18.9 in L [43 mm H x 426 mm W x 480 mm L]

Dimensions with option HI: 19" 1U enclosure

All models: 1.73 in H x 17.32 in W x 18.5 in L [44 mm H x 440 mm W x 470 mm L]