



**Model A2085 / A2255**

**Dual Channel Arbitrary Waveform  
Generator**

**User Manual**

December 2018 Edition, V1.0.1

Copyright © Berkeley Nucleonics Corporation. All rights reserved.

The Berkeley Nucleonics products are under the protection of the patent rights, including ones which have already obtained the patent rights and those which are applied for. The information in this manual will replace all materials published.

The information in this manual was correct at the time of printing. However, Berkeley Nucleonics will continue to improve products and reserves the rights to change specification at any time without notice.

BNC is the registered trademark of Berkeley Nucleonics.

**Berkeley Nucleonics Corporation**

2955 Kerner Blvd, San Rafael CA 94901

Phone: 415-453-9955, Fax: 415-453-9956

Web: [www.berkeleynucleonics.com](http://www.berkeleynucleonics.com)

# General Warranty

BERKELEY NUCLEONICS warrants that the product will be free from defects in materials and workmanship for 3 years from the date of purchase of the product by the original purchaser from the BERKELEY NUCLEONICS Company. The warranty period of accessories such as probe, battery, adapter is 12 months. This warranty only applies to the original purchaser and is not transferable to the third party.

If the product proves defective during the warranty period, BERKELEY NUCLEONICS either will repair the defective product without charge for parts and labor or will provide a replacement in exchange for the defective product. Parts, modules and replacement products used by BERKELEY NUCLEONICS for warranty work may be new or reconditioned like new performance. All replaced parts, modules and products become the property of BERKELEY NUCLEONICS.

To obtain service under this warranty, Customer must notify BERKELEY NUCLEONICS of the defect before the expiration of the warranty period. Customer shall be responsible for packaging and shipping the defective product to the service center designated by BERKELEY NUCLEONICS, and with a copy of customer proof of purchase.

This warranty shall not apply to any defect, failure or damage caused by improper use or improper or inadequate maintenance and care. BERKELEY NUCLEONICS shall not be obligated to furnish service under this warranty a) to repair damage resulting from attempts by personnel other than BERKELEY NUCLEONICS representatives to install, repair or service the product; b) to repair damage resulting from improper use or connection to incompatible equipment; c) to repair any damage or malfunction caused by the use of non-BERKELEY NUCLEONICS supplies; or d) to service a product that has been modified or integrated with other products when the effect of such modification or integration increases the time or difficulty of servicing the product.

# Table of Contents

1. General Safety Requirement .....	1
2. Safety Terms and Symbols.....	2
3. Introduction .....	3
4. Quick start.....	4
Front panel.....	4
Rear Panel .....	6
Power On.....	7
User Interface .....	8
Use Build-in Help.....	9
5. Panel Operation .....	10
Channel Setting .....	10
Select the channel for configuration .....	10
Turn On/Off Channel Output.....	10
Channel Copy .....	10
Waveform Setting.....	10
Sine Wave Output .....	11
Set the frequency/period .....	11
Set the amplitude.....	12
Set the offset .....	12
Set the high level.....	12
Set the low level.....	12
Set the start phase .....	13
Output the square wave.....	13
Output the Ramp Wave.....	14
Set the symmetry .....	14
Output the pulse .....	15
Set the pulse width/duty cycle.....	18
Set the rising/falling time.....	19
Output the Noise Wave .....	19
Output the Arbitrary Wave .....	20
Choose build-in waves.....	20
Output the harmonic wave .....	25
Harmonic wave function overview .....	25
Select the harmonic type .....	26
Set the harmonic times .....	26
Set the harmonic number .....	26

Set the harmonic amplitude.....	26
Set the harmonic phase .....	27
Output the modulated waves .....	27
Amplitude Modulation(AM).....	28
Frequency Modulation ( FM ) .....	29
Phase Modulation ( PM ) .....	31
Pulse Width Modulation ( PWM ) .....	32
Amplitude shift keying ( ASK ) .....	33
Phase Shift Keying ( PSK ) .....	35
Frequency Shift Keying ( FSK ) .....	37
Hexadecimal frequency shift keying ( 3FSK ) .....	38
Quaternary frequency shift keying ( 4FSK ) .....	39
Binary phase shift keying ( BPSK ) .....	40
Oscillating keying ( OSK ) .....	41
Output the sweep frequency ( Sweep ) .....	43
Output the burst ( Burst ) .....	44
Set N cycle burst.....	45
Set the gated burst.....	46
Counter .....	47
Utility function setting .....	48
Display Setting.....	48
Brightness Control.....	48
Screen Saver.....	49
Separator.....	49
Date.....	49
CH1/2 Settings.....	49
Synchronize .....	49
Output Setting.....	50
Set the load .....	50
Interface Setting.....	51
System Setting.....	52
Select the language.....	52
Buzzer.....	52
Clock source .....	52
Clock Output.....	53
Firmware update.....	53
Restore to factory setting.....	53
Edit the Arbitrary Wave ( Edit ) .....	57
File system ( Store ) .....	58
Save Current Arbitrary Wave.....	59
Bring up arbitrary wave files in internal/external memory.....	59
Clear waveform from memory .....	60
Save/recall instrument settings ( Preset ) .....	61
Use build-in help ( Help ) .....	61

6. Communicate with PC..... 62

7. Troubleshooting ..... 64

8. Specification..... 65

9. Appendix..... 73

    Appendix A: Accessories ..... 73

    Appendix B: Maintenance and cleaning..... 73

# 1. General Safety Requirement

Before use, please read the following safety precautions to avoid any possible bodily injury and to prevent this product or any other connected products from damage. To avoid any contingent danger, ensure this product is only used within the range specified.

Only the qualified technicians can implement the maintenance.

To avoid Fire or Personal Injury:

- **Use Proper Power Cord.** Use only the power cord supplied with the product and certified to use in your country.
- **Product Grounded.** This instrument is grounded through the power cord grounding conductor. To avoid electric shock, the grounding conductor must be grounded. The product must be grounded properly before any connection with its input or output terminal.
- **Check all Terminal Ratings.** To avoid fire or shock hazard, check all ratings and markers of this product. Refer to the user's manual for more information about ratings before connecting to the instrument.
- **Do not operate without covers.** Do not operate the instrument with covers or panels removed.
- **Use Proper Fuse.** Use only the specified type and rating fuse for this instrument.
- **Avoid exposed circuit.** Do not touch exposed junctions and components when the instrument is powered.
- **Do not operate if in any doubt.** If you suspect damage occurs to the instrument, have it inspected by qualified service personnel before further operations.
- **In well-ventilated area.** Make sure the instrument installed with proper ventilation, refer to the user manual for more details.
- **Do not operate in wet conditions.**
- **Do not operate in an explosive atmosphere.**
- **Keep product surfaces clean and dry.**

## 2. Safety Terms and Symbols

### Safety Terms

**Terms in this manual.** The following terms may appear in this manual:



**Warning:** Warning indicates the conditions or practices that could result in injury or loss of life.



**Caution:** Caution indicates the conditions or practices that could result in damage to this product or other property.

**Terms on the product.** The following terms may appear on this product:

**Danger:** It indicates an injury or hazard may immediately happen.

**Warning:** It indicates an injury or hazard may be accessible potentially.

**Caution:** It indicates potential damage to the instrument or other property might occur.

### Safety Symbols

**Symbols on the product.** The following symbol may appear on the product:



Hazardous Voltage



Refer to Manual



Protective Earth Terminal



Chassis Ground



Test Ground



### 3. Introduction

This product is a dual-channel multi-function signal generator integrated with an arbitrary waveform generator and function generator. The product uses DDS direct digital frequency synthesis technology to generate stable, accurate and pure output signals; user-friendly interface design and keyboard layout, bringing extraordinary experience to users; support U disk storage, providing users with multiple solutions.

#### Product Features:

- ◆ 8-inch (800 x 600) high resolution TFT LCD display;
- ◆ Advanced DDS technology with a maximum output frequency of 200 MHz;
- ◆ 1.25G Sa/s maximum sampling rate, 1  $\mu$ Hz frequency resolution;
- ◆ 14 bits vertical resolution, up to 10 M point waveform length;
- ◆ Rich waveform output: 6 basic waveforms, built-in exponential rise, exponential decay,  $\text{Sin}(x)/x$ , step wave, etc. More than 150 built-in waveforms and user-defined waveforms;
- ◆ Rich modulation functions and output linear/logarithmic sweep and burst waveforms;
- ◆ Interface: USB Host, USB Device (Type B), LAN.

# 4. Quick start

## Front panel

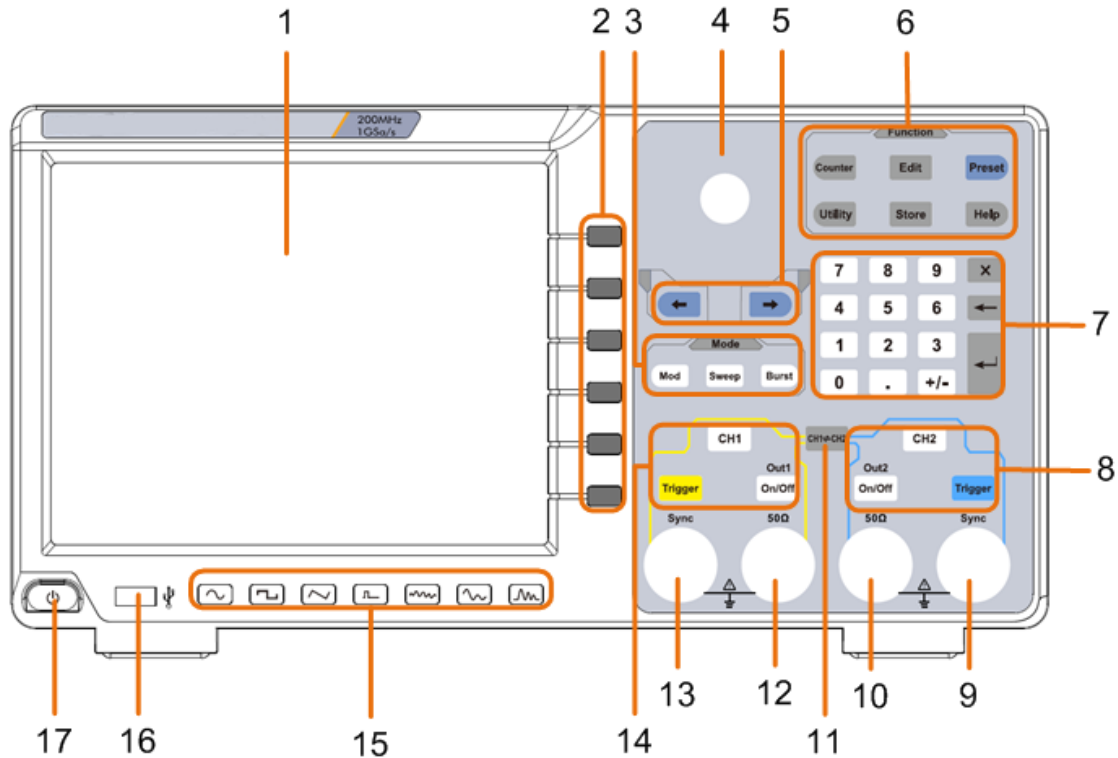

Figure 4-1 Front Panel overview







1	<b>Display Area</b>	Display user interface
2	<b>Menu Selection Button</b>	Includes 6 buttons to select the corresponding menu softkey
3	<b>Mode Button Area</b>	<p><b>Modulation (Mod):</b> Output modulation waveform</p> <p><b>Sweep:</b> Scan a sine wave, square wave, ramp wave or arbitrary wave</p> <p><b>Burst:</b> A burst that produces a sine wave, square wave, ramp wave, pulse wave, or arbitrary wave.</p>
4	<b>Knob</b>	Change the currently selected value, also used to select the character in the soft keyboard when the file location or file name is entered.
5	<b>Direction Button</b>	Move the cursor of the selected parameter
6	<b>Function Button Area</b>	<p><b>Counter:</b> Enter the frequency meter interface</p> <p><b>Wave Edit (Edit):</b> enter the waveform editing interface</p> <p><b>Preset:</b> Enter the preset menu, set the reset parameters or</p>

---

		power-on parameters; save or read the settings file.
		<b>Utility:</b> Set the auxiliary system function
		<b>Store:</b> Save/recall arbitrary waveform data
		<b>Help:</b> To get context help for any front panel button or menu softkey, press the button and then press the button for which you need help.
7	<b>Numerical Keypad</b>	Input the parameter
8	<b>CH2 Button Area</b>	<p><b>CH2 key:</b> Enter the waveform interface and select the CH2 channel (the backlight of the button lights up). After selecting, the waveform and parameters of CH2 can be set.</p> <p><b>Blue Trigger button:</b> CH2 manual trigger button. In sweep or burst mode, when the trigger source is selected as “Manual,” each press of this button will initiate a trigger.</p> <p><b>On/Off key:</b> Turns the output of the CH2 channel on or off. When the output is turned on, the backlight of the button lights up.</p>
9	<b>CH2 Sync Output Terminal</b>	When <b>Utility</b> → <b>CH1/2 Set</b> → <b>CH2 Sync</b> turned on, this terminal outputs a sync signal that matches the current configuration of CH2.
10	<b>CH2 Output Terminal</b>	Output CH2 signal
11	<b>CH1⇌CH2 Button</b>	Display channel copy menu and menu of frequency synchronization, amplitude synchronization, phase alignment, etc.
12	<b>CH1 Output Terminal</b>	Output CH1 signal
13	<b>CH1 Sync Output Terminal</b>	When <b>Utility</b> → <b>CH1/2 Set</b> → <b>CH1 Sync</b> turned on, this terminal outputs a sync signal that matches the current configuration of CH1.
14	<b>CH1 Button Area</b>	<p><b>CH1 key:</b> Enter the waveform interface and select the CH1 channel (the backlight of the button lights up). After selecting, the waveform and parameters of CH1 can be set.</p> <p><b>Yellow Trigger button:</b> CH1 manual trigger button. In sweep or burst mode, when the trigger source is selected as “Manual,” each press of this button will initiate a trigger.</p> <p><b>On/Off key:</b> Turns the output of the CH1 channel on or off. When the output is turned on, the backlight of the button</p>

---

lights up.

15 <b>Waveform Selection Area</b>	Including sine  , square  , ramp  , pulse  , noise  , arbitrary wave  , harmonic waves  . When one waveform is selected, the corresponding backlight will be lit.
16 <b>USB Interface</b>	Connect to an external USB Host device, such as a USB flash drive.
17 <b>Power Button</b>	Turn on/off the waveform generator

## Rear Panel

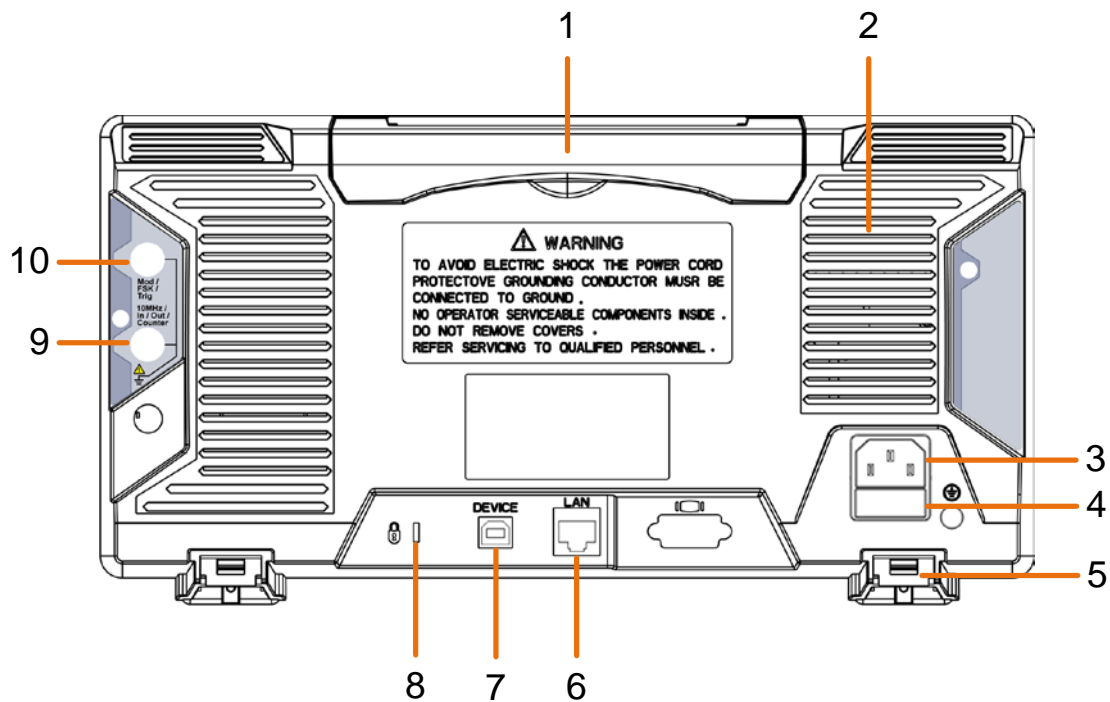

Figure 4-2 Rear Panel Overview

1 <b>Retractable Handle</b>	
2 <b>Vents</b>	
3 <b>Power Input Socket</b>	AC power input interface.
4 <b>Fuse Box</b>	The place to install the fuse.
5 <b>Stool</b>	Tilting the signal generator for easy operation.
6 <b>LAN Interface</b>	The signal generator is connected to the local area network through this interface for remote control.

---

7	<b>USB Device Interface</b>	Used to connect a USB type B controller. The PC can be connected to communicate with the signal generator through the host computer software.
8	<b>Keyhole</b>	A safety lock (please buy it yourself) can be used to lock the instrument in a fixed position to secure the instrument.
9	<b>10MHz In/Out/Counter(Reference clock input / output / frequency meter input) connector</b>	The default is to receive the frequency meter input signal. Used to receive a 10MHz clock signal when the instrument is set to an internal clock source and <b>Utility</b> → <b>System</b> → <b>CLK output</b> is On; it is used to receive an external 10MHz clock signal when the instrument is set to an external clock source.
10	<b>Mod/FSK/Trig (modulation/trigger input) connector</b>	When modulating the waveform, outputting the sweep frequency, and the burst, the signal accessed here can be used as an external source. Note: If one channel turns on AM, FM, PM, PWM or OSK, and the other channel turns on ASK, FSK, PSK, sweep or burst, and both channels are set to external trigger, then the channel that sets the trigger source can be set later. With an external trigger, the other channel automatically cancels the external trigger because of the different external modulation signal types.

---

## Power On

- (1) Connect the instrument to an AC power source using the power cord supplied with the accessory



### Warning:

To prevent electric shock, make sure the instrument is properly grounded.

---

- (2) Press the **power button** on the front panel and the screen will display the booting screen.

## User Interface

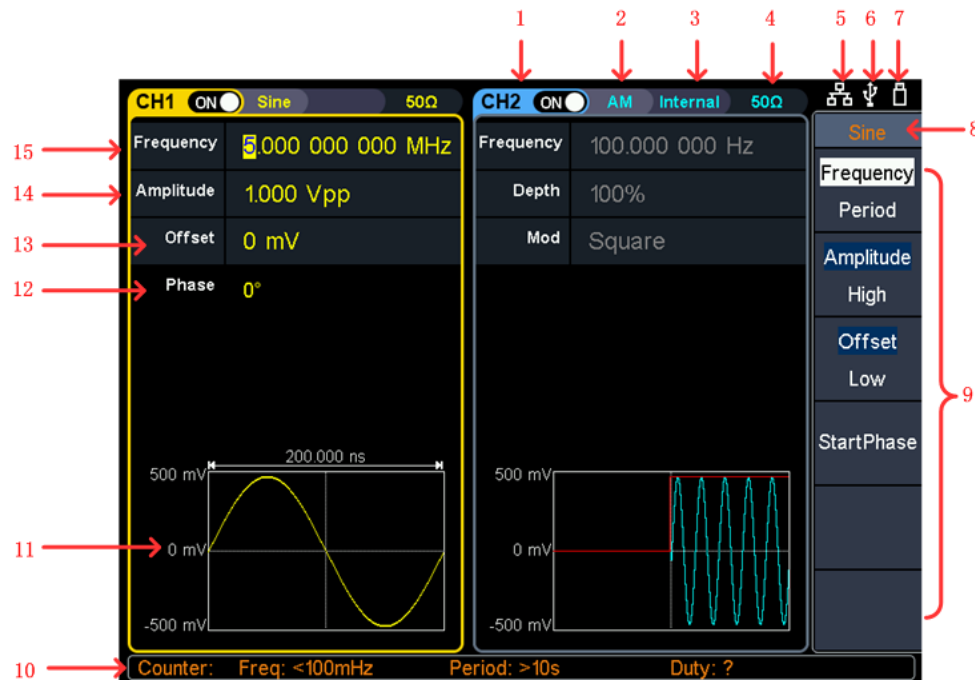

Figure 4-3 User Interface

1	Display channel name and channel status
2	Current waveform or current mode
3	Trigger source. Internal: internal modulation or internal trigger source External: external modulation or external trigger source Manual: manual trigger source
4	Load, High Z indicates high resistance
5	This icon is lit when the network is connected through the LAN
6	This icon is lit when connected to the USB Host via the USB DEVICE interface.
7	When the instrument detects the USB flash drive, the icon lights.
8	Current menu name
9	Current waveform or mode setting menu
10	Frequency meter brief information, displays the frequency value, period and the duty value
11	Display a schematic of the current waveform
12	Display the current starting phase
13	Offset / low level, depending on the right highlighted the menu item
14	Amplitude / high level, depending on the right highlighted menu item

---

15 Frequency/cycle, depending on the right highlighted menu item

---

## Use Build-in Help

- (1) To get help on any front panel button or menu softkey, press the front panel **Help** function button first, then press the button you need help.
- (2) Press the **Help** function key again to exit the help interface.

## 5. Panel Operation

### Channel Setting

#### Select the channel for configuration

Before configuring waveform parameters, you must select the channel you want to configure. Press **CH1** or **CH2** to select the corresponding channel and the corresponding channel area in the user interface will light up







#### Turn On/Off Channel Output

Press the front panel CH1 **On/Off** or CH2 **On/Off** button to turn the output of the corresponding channel on/off. When the output is turned on, the backlight of the button lights up.

### Channel Copy

- (1) Press **CH1⇌CH2** on the front panel to display copy menu.
- (2) Select **CH2 to CH1** softkey or **CH1 to CH2** softkey to copy the channel.

### Waveform Setting

Sine, square, ramp, pulse, noise, arbitrary or harmonic waves can be set and output. Press the waveform selection button on the instrument front panel: sine , square , ramp , pulse , noise , arbitrary wave , harmonic , and enter the corresponding waveform setting interface. The waveform is different, and the parameters that can be set are different.

**Note:** The following setting waveform uses CH1 channel as an example. If you need to set CH2 channel, please refer to CH1 channel specific operation.



## Sine Wave Output

Press , the screen displays the user interface of the sine wave. By operating the sine wave menu on the right side of the screen, you can set the output waveform parameters of the sine wave.

The sine wave menu includes frequency/period, amplitude/high level, offset/low level, and start phase. The menu can be operated by the menu selection button on the right.

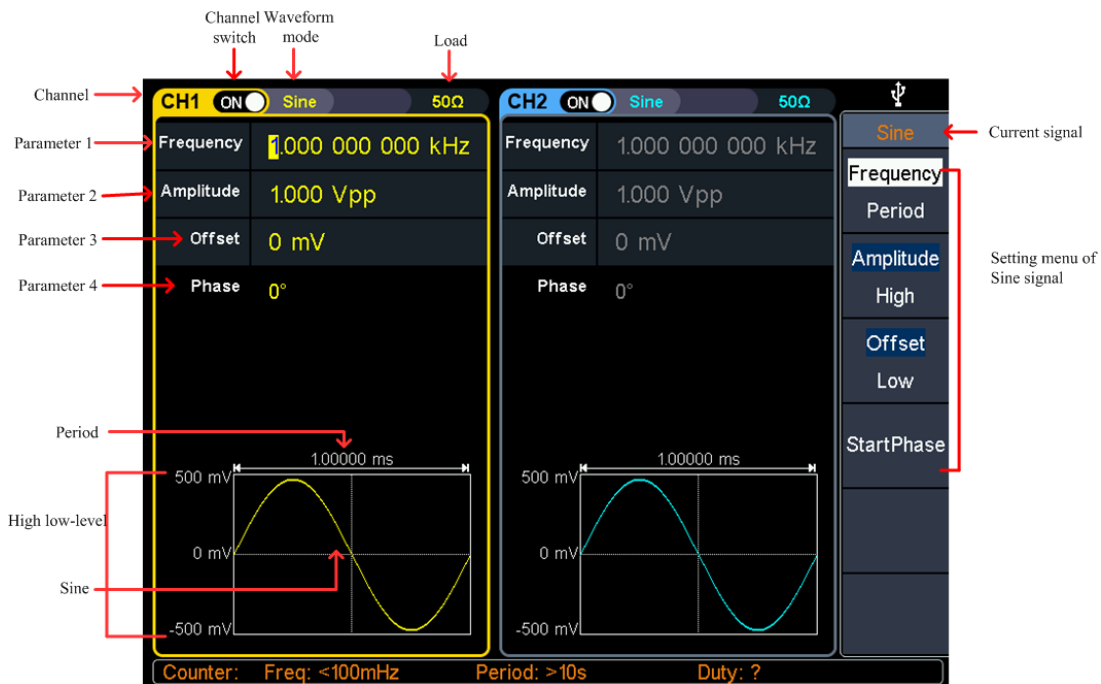





Figure 5-1: Sine wave user interface

### Set the frequency/period

- Press **CH1**, all currently selected **CH1** menu items are highlighted
- Press the **Frequency/Period** soft key, the currently selected menu item is highlighted, and the corresponding parameter item is displayed in **parameter 1**. Press the **Frequency/Period** softkey again to switch the frequency and period.

### There are two ways to change the selected parameter value:

- Turn the **knob** to increase or decrease the value at the cursor. Press the / arrow key to move the cursor left or right.
- Press a number key on the **numeric keypad** directly; the screen will pop out the data input box, input the desired value. Press the **X** soft key to delete the last digit, press the  soft key to cancel the input, and press the **Enter** soft key to indicate the default unit input. Press the **MHz, kHz, Hz, mHz, mHz** soft keys to

select the unit of the parameter. Press the **Cancel** softkey to cancel the current input parameter value.

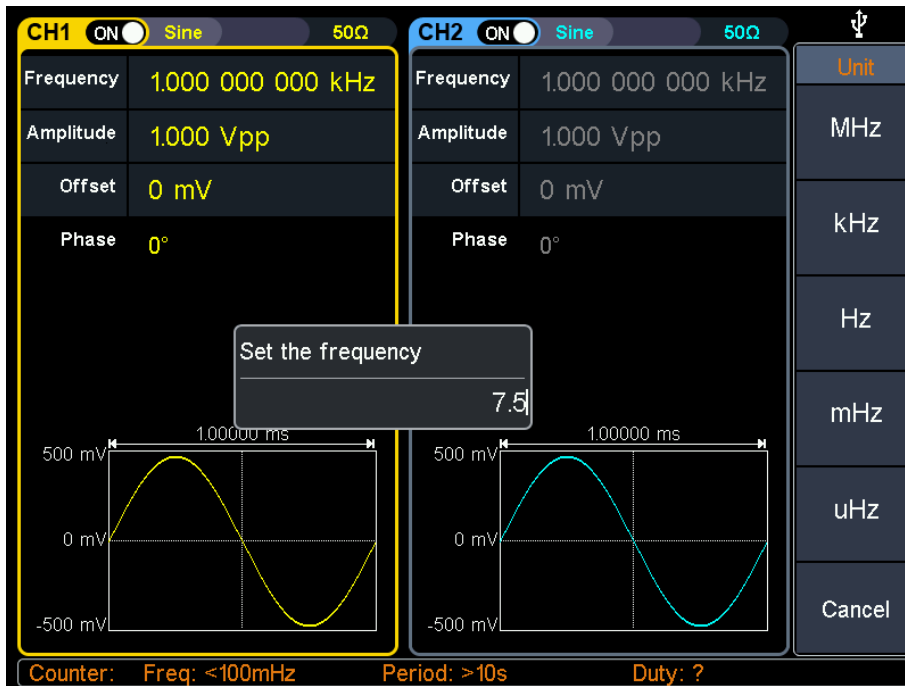

Figure 5-2: Use the numeric keypad to set the frequency

### Set the amplitude

Press the **Amplitude/High Level** softkey to confirm whether the **Amplitude** menu item is highlighted; if not, press the **Ampl/High** button to switch to **Amplitude**. In **parameter 2** of Figure 5-1, the parameter value of the amplitude appears as a blinking cursor. Use the **knob** or **numeric keypad** to set the desired value.

### Set the offset

Press the **Offset/Low Level** softkey to confirm whether the **Offset** menu item is highlighted; if not, press the **Offset/Low level** key to switch to **Offset**. In **parameter 3** of Figure 5-1, the parameter value of the offset appears as a blinking cursor. Use the **knob** or **numeric keypad** to set the desired value.

### Set the high level

Press the **Amplitude/High level** button to confirm whether the “High level” menu item is highlighted; if not, press the **Ampl/High level** button to switch to “High level.” In **parameter 2** of Figure 5-1, a high-level parameter value appears as a blinking cursor. Use the **knob** or **numeric keypad** to set the desired value.

### Set the low level

Press the **Off/Low level** button to confirm whether the “Low level” menu item is highlighted; if not, press the **Offset/Low level** button to switch to “Low level.” In

**parameter 3** of Figure 5-1, a low-level parameter value appears as a blinking cursor. Use the **knob** or **numeric keypad** to set the desired value.

### Set the start phase

Press the **Start Phase** softkey to confirm whether the **Start Phase** menu item is highlighted; if not, press the **Start Phase** key. In **parameter 4** of Figure 5-1, the parameter value of the starting phase appears as a blinking cursor. Use the **knob** or **numeric keypad** to set the desired value

### Output the square wave

Press , the screen displays the square wave user interface. By operating the square wave menu on the right side of the screen, you can set the square wave output waveform parameters.

The square wave menu includes: **frequency/period**, **amplitude / high level**, **offset / low level**, **starting phase**.

For the setting frequency/period, amplitude/high level, offset/low level, and starting phase, please refer to “Output Sine Wave” of P9.

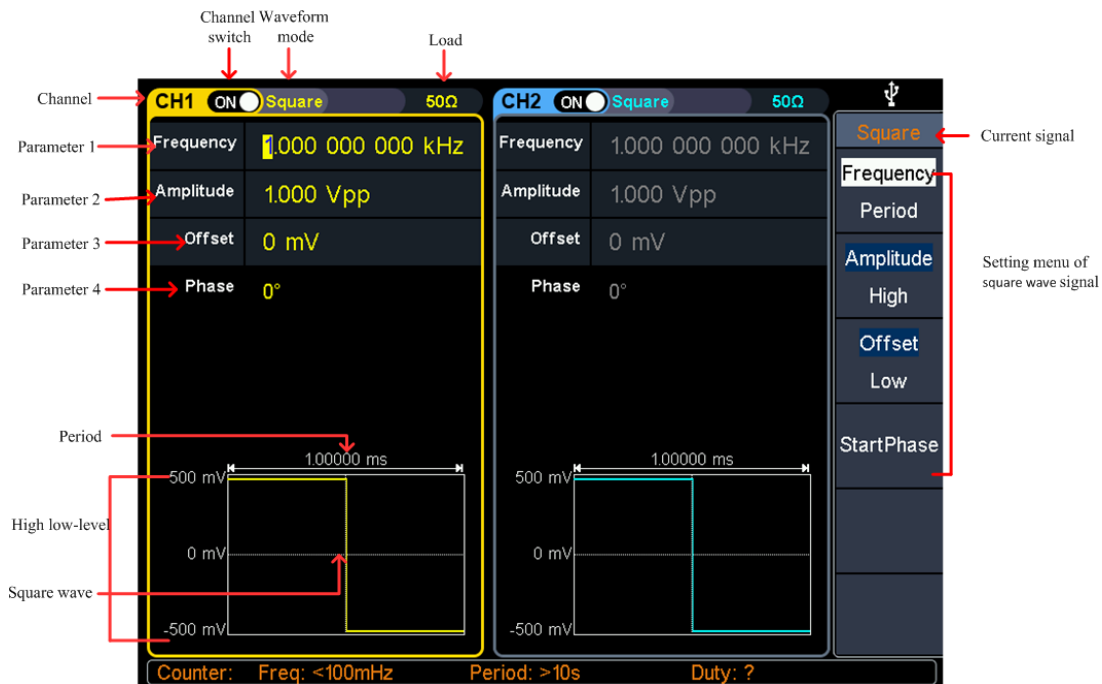



Figure 5-3: Square wave user interface

## Output the Ramp Wave

Press , the screen displays the user interface of the ramp wave. By operating the ramp menu on the right side of the screen, you can set the output waveform parameters of the ramp wave.

The ramp menu includes: frequency/period, amplitude/high level, offset/low level, symmetry.

For the setting frequency/period, amplitude/high level, offset/low level, and starting phase, please refer to “Output Sine Wave” of P9.

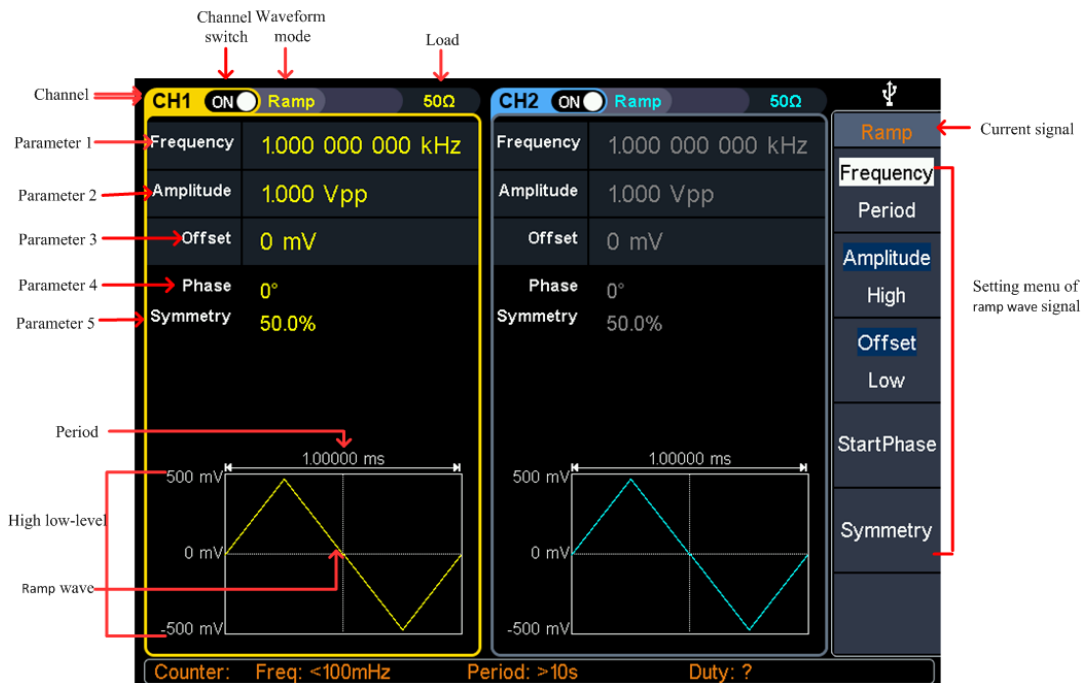

Figure 5-4: Ramp wave user interface

### Glossary

**Symmetry:** Sets the percentage of the period during which the ramp waveform is rising.

### Set the symmetry

- (1) Press the **Symmetry** softkey to select the **Symmetry** menu item. Figure 5-6  
**Parameter 1** shows the current value of the symmetry;
- (2) Use the **knob** to change directly, the value in **parameter 1** of Figure 5-6; Or use the numeric keypad to enter the value, press the **%** or **Enter** key to

display the symmetrical value of the input, press the  $\times$  soft key to delete the last digit, press the  $\leftarrow$  soft key to cancel the input, and press the **Enter** softkey to indicate the default input.

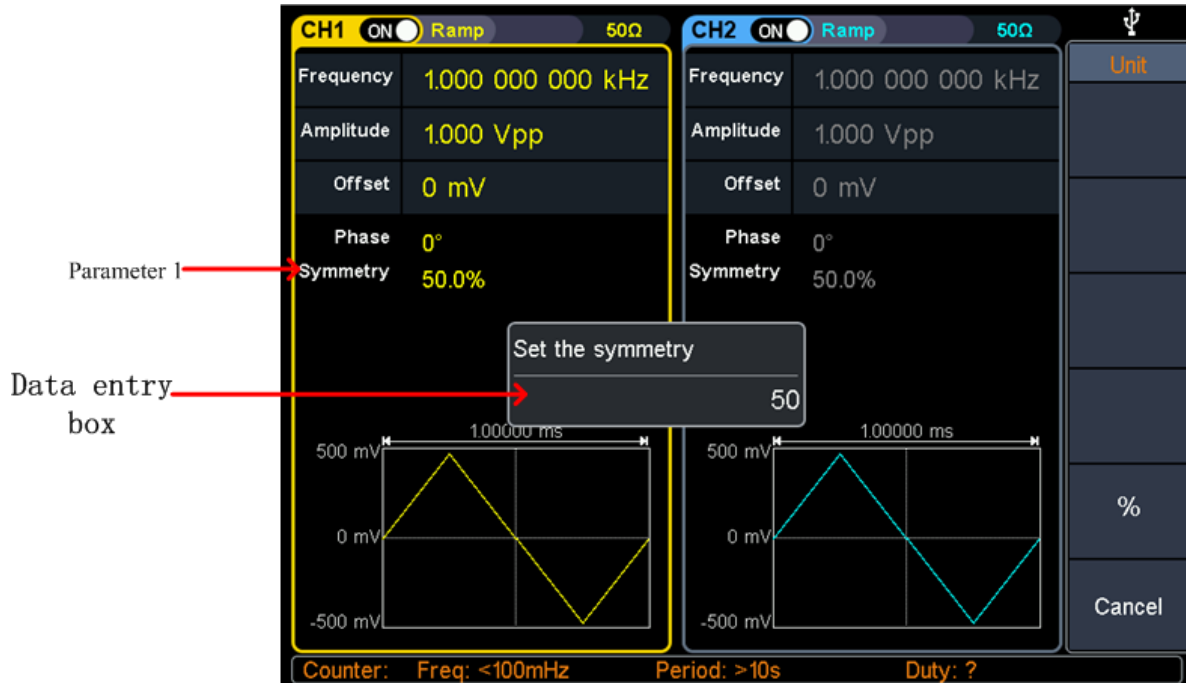

Figure 5-5: Set the symmetry of ramp wave

## Output the pulse

Press  $\square$ , the screen displays the user interface of the pulse wave. By operating the pulse wave menu on the right side of the screen, the output waveform parameters of the pulse wave can be set.

The pulse wave menu includes: frequency/period, amplitude/high level, offset/low level, start phase, pulse width/duty cycle, rise time/fall time.

For the setting frequency/period, amplitude/high level, offset/low level, and starting phase, please refer to “Output Sine Wave” of P9.

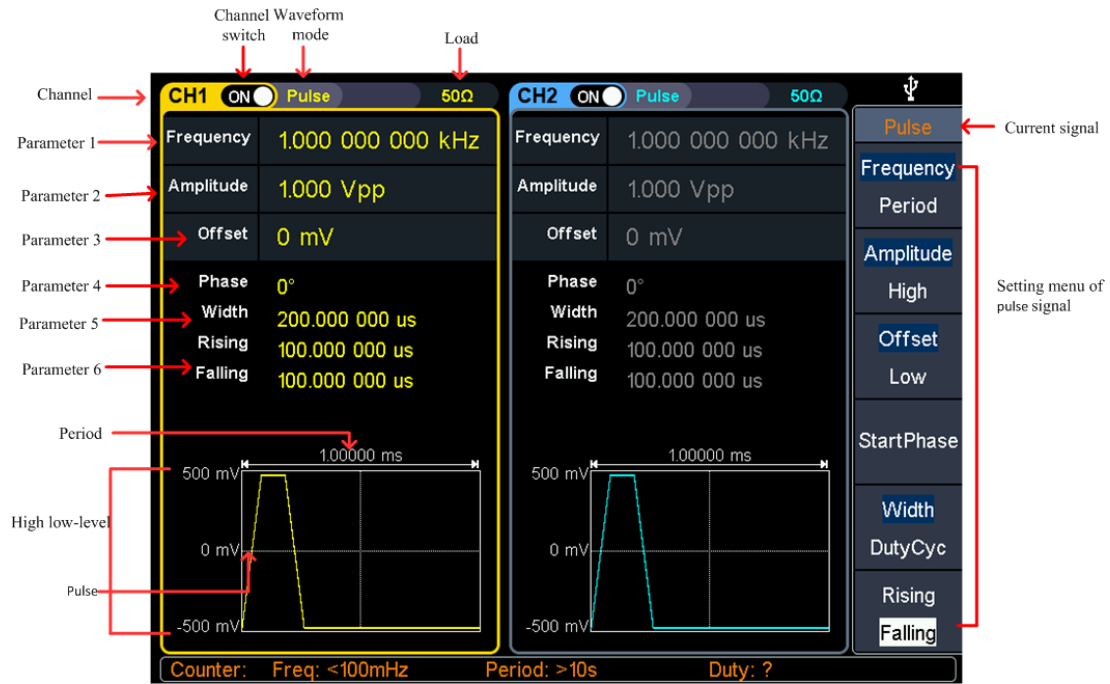

Figure 5-6: Pulse wave user interface

## Glossary

### Pulse Width:

PW is an abbreviation for pulse width and is divided into a positive pulse width and negative pulse width.

The positive pulse width is the time interval from 50% of the rising edge to 50% of the adjacent falling edge.

The negative pulse width is the time interval from 50% of the falling edge to 50% of the adjacent rising edge.

The pulse width is determined by the period and duty cycle of the signal. The calculation formula is pulse width = period \* duty cycle.

### Duty Cycle:

In a series of ideal pulse sequences (such as a square wave), the ratio of the duration of the positive pulse to the total pulse period.

### Pulse/Duty Cycle:

The pulse width is defined as the time interval from the 50% threshold of the amplitude of the rising edge of the pulse to the 50% threshold of the amplitude of the next falling edge, as shown in the following figure.

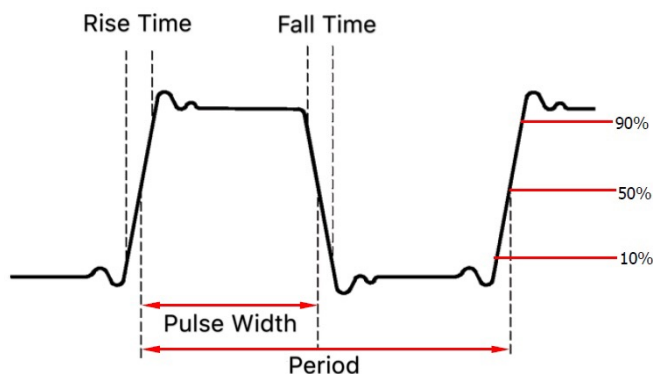

- The settable range of pulse width is limited by the "minimum pulse width" and "pulse period."

$$\text{Pulse width} \geq \text{minimum pulse width}$$

$$\text{Pulse width} \leq \text{pulse period} - \text{minimum pulse width}$$

- The pulse duty cycle is defined as the pulse width as a percentage of the pulse period.

- The pulse duty cycle is associated with the pulse width, and modifying one of the parameters will automatically modify the other parameter. The pulse duty cycle is limited by the "minimum pulse width" and "pulse period."

$$\text{Pulse duty cycle} \geq \frac{\text{minimum pulse width}}{\text{pulse period}} \times 100\%$$

$$\text{Pulse duty cycle} \leq \frac{(\text{pulse period} - 2 \times \text{minimum pulse width})}{\text{pulse period}} \times 100\%$$

## Set the pulse width/duty cycle

Press the **Pulse Width/Duty Cycle** softkey to select the Pulse Width menu item. As shown in Figure 5-7, parameter 1 displays the current value of the pulse width. Press the **Pulse Width/Duty Cycle** button to display the duty cycle.

Set the pulse width parameter value, use the **knob** to directly change the value of the pulse width in **parameter 1** of Figure 5-7; or use the **numeric keypad** to enter the value, then select the desired unit from the right menu, press the desired unit (ks, s, ms, us, ns) or **Enter** the value; press the **X** soft key to delete the last digit, press the **←** soft key to cancel the input, and press the **Enter** soft key to indicate the default input.

Set the duty cycle parameter value, use the **knob** to directly change the value of the graph duty cycle; or use the **numeric keypad** to enter the value, then press **%** or **Enter** from the right menu to enter the demand value; press the **X** soft key to delete the last one. Bit, press the **←** soft key to cancel the input, press the **Enter** soft key to indicate the default input.

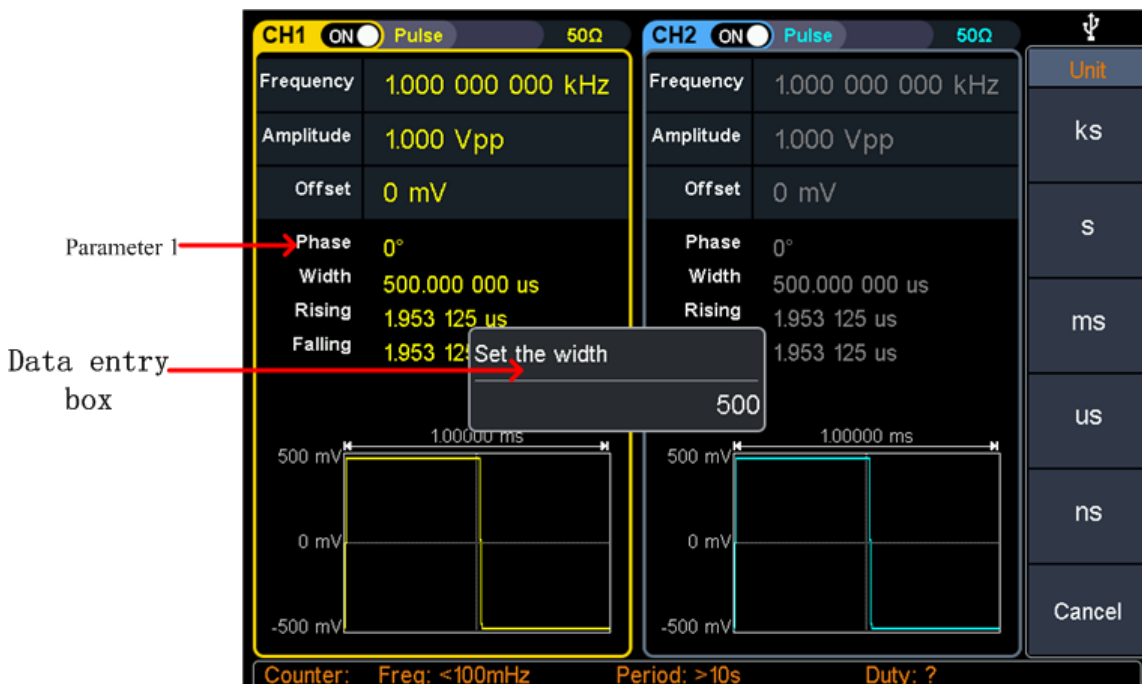



Figure 5-7: Set the pulse width



## Set the rising/falling time

Press the **rise time/fall time** soft key to select the "rise time/fall time" menu item, as shown in Figure 5-6, parameter 6 shows the current value of the rise/fall time; press the **rise time/fall time** key to switch between the current display — parameter value. Set the **rise time/fall time** parameter value Use the **knob** or use the **numeric keypad** to enter the value, then select the desired unit from the right menu, press the desired unit (ks, s, ms, us, ns) or **Enter** the value; press the **X** soft key to delete the last digit, press the **←** soft key to cancel the input, press the **Enter** softkey to indicate the default input.

## Output the Noise Wave

The noise wave output by the system is white noise. Press , the screen displays the user interface of the noise wave. By operating the noise wave menu on the right side of the screen, the output waveform parameters of the noise wave can be set.

The noise wave has no frequency and periodic parameters, and the bandwidth is 120 MHz of Gaussian noise.

The menu of noise waves includes **amplitude / high level, offset / low level**.

For the setting of amplitude/high level, offset/low level, please refer to "Output Sine Wave" of P9.



Figure 5-8: noise wave user interface

## Output the Arbitrary Wave

Press , the screen displays the user interface of the arbitrary wave. By operating the arbitrary wave menu on the right side of the screen, the output waveform parameters of the arbitrary wave can be set.

Arbitrary wave menus include frequency/period, amplitude/high level, offset/low level, start phase, built-in waveform.

For the setting frequency/period, amplitude/high level, offset/low level, and starting phase, please refer to “Output Sine Wave” of P9.

Arbitrary waves include two kinds of arbitrary waveforms: system built-in waveforms and user-edited waveforms.

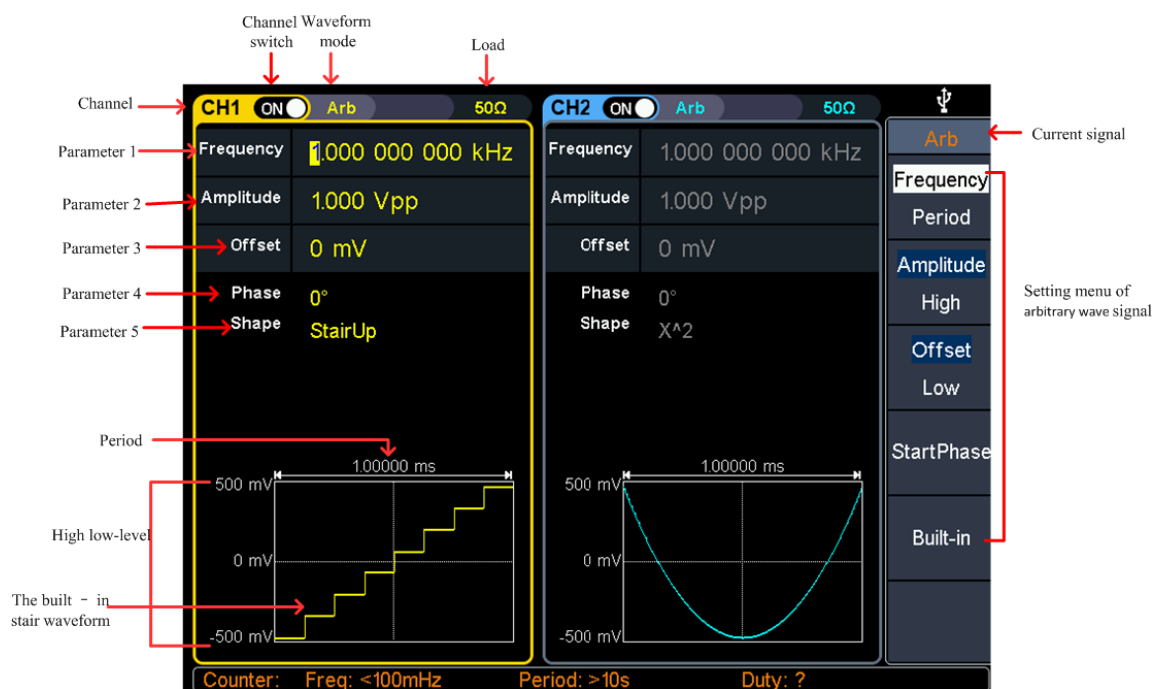



Figure 5-9: Arbitrary wave user interface

## Choose build-in waves

There are 152 types of waveforms built into the system, the number of waveform points is 8192 points, and the highest upper limit frequency is 15MHz. To select a built-in waveform, the steps are as follows:

(1) Press , then press the **built-in waveform** soft key to enter and select the menu

(2) Select the type of built-in waveform by **common**, **medical**, **standard**, **math** soft keys

Press **Next** menu to select the built-in waveform: **Trigonometric function**, **window function**, **engineering**, and **segmentation modulation**.

For example, select **Math** to enter the interface shown below.

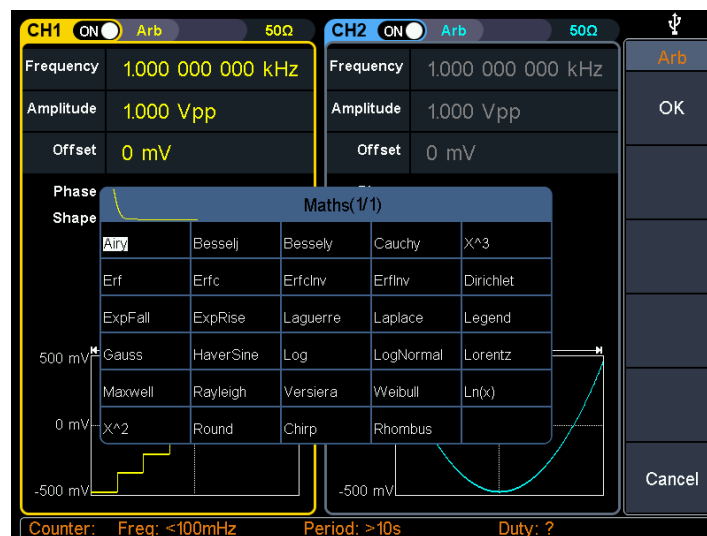

(3) Turn the **knob** to select the desired waveform, for example, select **Airy**. Press the **OK** soft key to enter the **Airy** function.

### Buld-in wave list:

Name	Description
<b>Common</b>	
DC	Direct current
AbsSine	Absolute sine
AbsSineHalf	Absolute half-sine
AmpALT	Gain oscillation curve
AttALT	Attenuation oscillation curve
GaussPulse	Gauss pulse
NegRamp	Negative ramp
NPulse	Negative pluse
PPulse	Positive pluse
SineTra	Sine-Tra wave
SineVer	Sine-Ver wave

StairDn	Stair downward
StairUP / UD	Stair upward/downward
Trapezia	Trapezia
<b>Medical</b>	
Heart	Heart
Cardiac	Cardiac
LFPulse	Low frequency pulse electrotherapy waveform
Tens1	Neuroelectric stimulation therapy waveform 1
Tens2	Neuroelectric stimulation therapy waveform 2
Tens3	Neuroelectric stimulation therapy waveform 3
EOG	Electrooculogram
EEG	electroencephalogram
Pulseilogram	Ordinary pulse curve
ResSpeed	Ordinary expiratory flow rate curve
<b>Standard</b>	
Ignition	Automobile internal combustion engine ignition waveform
TP2A	Automotive transients due to inductance in the wiring
ISP	Automobile starting profile with oscillation
VR	Working voltage profile of the car when resetting
TP1	Automotive transients due to power cuts
TP2B	Car transients due to startup switching off
P4	Car working profile during start-up
TP5A	Car transients due to the power cut of battery
TP5B	Car transients due to the power cut of battery
SCR SCR	Sintering temperature release map
Surge	Surge signal
<b>Math</b>	
Airy	Airy function
Besselj	Type I Bessel function
Bessely	Type II Bessel function
Cauchy	Cauchy distribution
X^3	Cubic function
Erf	Error function
Erfc	Remnant error function
ErfcInv	Anti-complement error function
ErfInv	Inverse error function
Dirichlet	Dirichlet function
ExpFall	Exponential decline function
ExpRise	Exponential rise function
Laguerre	Four Laguerre polynomials
Laplace	Laplace distribution
Legend	Five Legendre polynomials
Gauss	Gaussian distribution, also known as the normal distribution

HaverSine	Semi-positive function
Log	Base 10 logarithmic function
LogNormal	Lognormal distribution
Lorentz	Lorentz function
Maxwell	Maxwell distribution
Rayleigh	Rayleigh distribution
Versiera	Tongue line
Weibull	Weber distribution
Ln(x)	Natural logarithmic waveform
X^2	Square function
Round	Round wave
Chirp	Linear frequency modulation
Rhombus	Diamond wave
<b>Trigonometric function</b>	
CosH	Hyperbolic cosine
Cot	Cotangent function
CotH	Hyperbolic cotangent
CotHCon	Concave hyperbolic cotangent
CotHPro	Raised hyperbolic cotangent
CscCon	Recessed cosecant
Csc	Cosecant
CscPro	Raised cosecant
CscH	Hyperbolic cosecant
CscHCon	Depressed hyperbolic cosecant
CscHPro	Raised hyperbolic cosecant
RecipCon	Reciprocal of the depression
RecipPro	Raised countdown
SecCon	Depression secant
SecPro	Raised secant
SecH	Hyperbolic secant
Sinc	Sinc function
SinH	Hyperbolic sine
Sqrt	Square root function
Tan	Tangent function
TanH	Hyperbolic tangent
ACos	Inverse cosine function
ACosH	Inverse hyperbolic cosine function
ACot	Anti-cotangent function
ACotCon	Inverse cotangent function
ACotPro	Raised inverse cotangent function
ACotH	Inverse hyperbolic cotangent function
ACotHCon	Inverse hyperbolic cotangent function
ACotHPro	Raised inverse hyperbolic cotangent function

Acsc	Anti-cosecting function
ACscCon	Concave inverse cosecting function
ACscPro	Raised anti-cosecting function
AcscH	Anti-hyperbolic cosecant
ACscHCon	Inverse hyperbolic cotangent function
ACscHPro	Raised inverse hyperbolic cosecant function
Asec	Inverse cut function
ASecCon	Inverse tangent function
ASecPro	Raised arctangent function
ASecH	Inverse hyperbolic secant function
ASin	Inverse sine function
ASinH	The inverse hyperbolic sine function
ATan	Arc tangent function
ATanH	The inverse hyperbolic tangent function
<b>Window Function</b>	
Bartlett	Bartlett window
BarthannWin	Modified Bartlett window
Blackman	Blackman window
BlackmanH	BlackmanH window
BohmanWin	BohmanWin window
Boxcar	Rectangular window
ChebWin	Chebyshev window
FlattopWin	Flat top window
Hamming	Hamming window
Hanning	Hanning window
Kaiser	Kaiser window
NuttallWin	The smallest four Blackman-Harris windows
ParzenWin	Parzen window
TaylorWin	Taylaor window
Triang	Triangle window, also call Fejer window
TukeyWin	Tukey window
<b>Engineering Window</b>	
Butterworth	Butterworth filter
Combin	Combined function
CPulse	C-Pulse signal
CWPulse	CW pulse signal
RoundHalf	Half-round wave
BandLimited	Band limited signal
BlaseiWave	Blasting vibration "time-vibration speed" curve
Chebyshev1	Type I Chebyshev filter
Chebyshev2	Type II Chebyshev filter
DampedOsc	Damped oscillation "time-displacement" curve
DualTone	Dual audio signal

Gamma	Gamma signal
GateVibar	Gate self-vibration signal
LFMPulse	Chirp signal
MCNoise	Mechanical construction noise
Discharge	NiMH battery discharge curve
Quake	Seismic wave
Radar	Radar signal
Ripple	Ripple
RoundsPM	RoundsPM wave
StepResp	Step response signal
SwingOsc	Swing oscillation kinetic energy-time curve
TV	TV signal
Voice	Voice signal
<b>Segment Modulation</b>	
I AM	Sinusoidal segmented AM wave
FM	A sinusoidal segmented FM wave
PM	Sinusoidal segmented PM wave
PWM	Pulse width segmented PWM wave

## Output the harmonic wave

Press  to display the harmonic user interface. You can set the harmonic output waveform parameters by operating the harmonic menu on the right side of the screen.

Harmonic menus include frequency/period, amplitude/high level, offset/low level, start phase, harmonic type, harmonic order, sequence number, harmonic amplitude, harmonic phase.

For the setting frequency/period, amplitude/high level, offset/low level, and starting phase, please refer to "Output Sine Wave" of P9.

## Harmonic wave function overview

According to the Fourier transform theory, the time domain waveform is a superposition of a series of sine waves, expressed by the following equation:

$$f(t) = A_1 \sin(2\pi f_1 t + \varphi_1) + A_2 \sin(2\pi f_2 t + \varphi_2) + A_3 \sin(2\pi f_3 t + \varphi_3) + \dots$$

Generally, the component of frequency  $f_1$  is called the fundamental wave,  $f_1$  is the fundamental

frequency,  $A_1$  is the fundamental amplitude, and  $\varphi_1$  is the fundamental phase. Also, the frequency of each component is usually an integer multiple of the fundamental frequency, which is called harmonic. A component whose frequency is an odd multiple of the fundamental frequency is called an odd harmonic, and a component whose frequency is an even multiple of the fundamental frequency is called an even harmonic.

This signal source can output up to 16 harmonic orders. After selecting CH1 or CH2, press the

front panel  button to enter the harmonic setting menu. You can set the parameters of the fundamental, select the type of output harmonics, specify the maximum number of output harmonics, and the amplitude and phase of each harmonic.

## Select the harmonic type

This signal source can output even harmonics, odd harmonics, all harmonics or user-defined harmonics. Enter the harmonic setting menu and press the harmonic type softkey to select the desired harmonic type.

### Even harmonic

Press the **Harmonic Type** softkey menu, and the instrument outputs the fundamental and even harmonics.

### Odd harmonic

Press the **Harmonic Type** softkey menu, and the instrument outputs the fundamental and odd harmonics.

### Order harmonic

Press the **Harmonic Type** softkey menu, and the instrument outputs the fundamental and harmonics in sequence.

customize

Press the Harmonic Type softkey to customize the number of times the harmonics are output. The maximum number of times is 16. The 16-bit binary data is used to represent the output state of the 16th harmonic, respectively, 1 means the output of the corresponding subharmonic is turned on, and 0 means the output of the corresponding subharmonic is turned off. The user only needs to use the numeric keypad to modify the value of each data bit (note: the leftmost bit indicates the fundamental wave, fixed to X, and modification is not allowed). For example, set 16-bit data to X001 0000 0000 0001, indicating the output fundamental, 4th harmonic, and 16th harmonic. **Note: The harmonics of the actual output are limited by the currently specified “harmonic times.”**

## Set the harmonic times

Press the **Next** soft key to enter the next page, and then press the **Harmonic Times** softkey to confirm whether the “Harmonic Times” menu item is highlighted; if not, press the **Harmonic Times** softkey. In parameter 5 of Figure 5-11, the parameter value of the harmonic order appears as a blinking cursor. Use the knob or numeric keypad to set the desired value, which can be set from 2 to 16 times.

## Set the harmonic number

Press the **Next** soft key to enter the next page, and then press the **Sequence** soft key to confirm whether the “Number” menu item is highlighted; if not, press the **Sequence** soft key. In parameter 6 of Figure 5-11, the parameter value of the serial number appears as a blinking cursor. Use the knob or numeric keypad to set the desired value, which can be set from 2 to 16 times.

## Set the harmonic amplitude

Press the **Next** soft key to enter the next page, and then press the **Harmonic Amplitude** softkey



to confirm whether the “Harmonic Amplitude” menu item is highlighted; if not, press the **Harmonic** softkey soft key. In parameter 7 of Figure 5-11, the parameter value of the harmonic amplitude appears as a blinking cursor. Use the knob or numeric keypad to set the desired value.

## Set the harmonic phase

Press **Next** to enter the next page, and then press the **Harmonic Phase** softkey to confirm whether the “Harmonic Phase” menu item is highlighted; if not, press the **Harmonic Phase** softkey. In parameter 8 of Figure 5-11, the parameter value of the harmonic phase appears as a blinking cursor. Use the knob or numeric keypad to set the desired value.

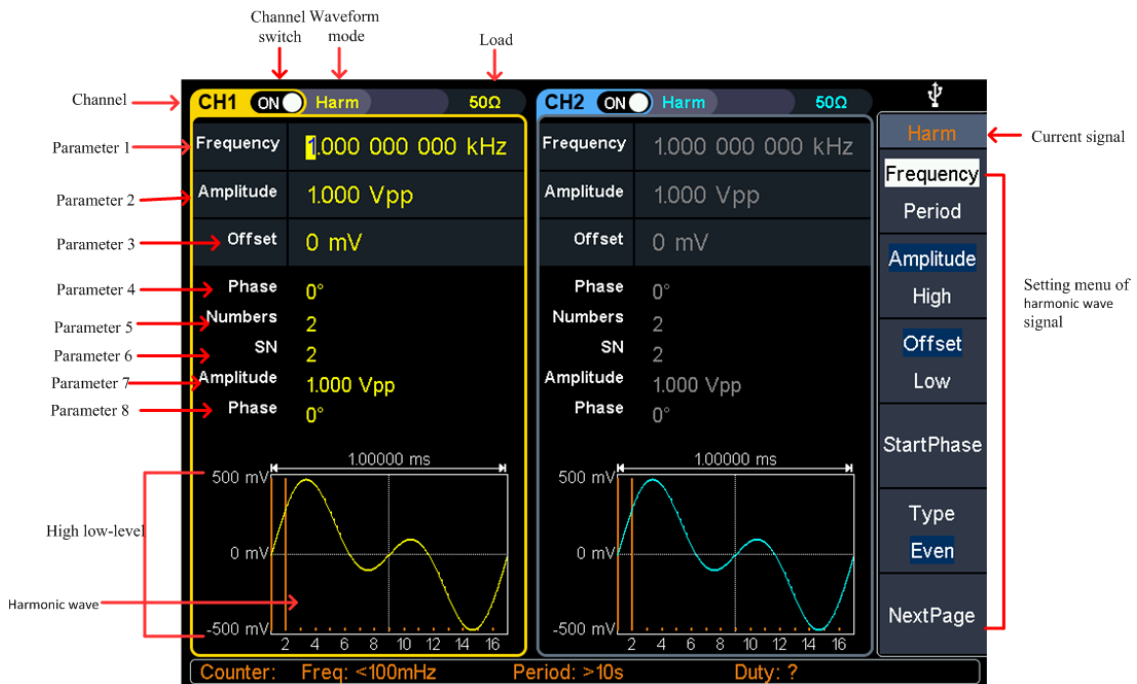

Figure 5-10 harmonic wave user interface

## Output the modulated waves

After pressing the **Mod** function key, press the **F1** key to select the modulation type to output the modulated waveform. Types that can be modulated include: AM (amplitude modulation), FM (frequency modulation), PM (phase modulation), PWM (pulse width modulation), ASK (amplitude shift keying), PSK (phase shift keying), FSK (frequency) Shift keying), 3FSK (ternary frequency shift keying), 4FSK (quadrature frequency shift keying), BPSK (biphase phase shift keying), OSK (oscillating keying).

**Note:** The following output modulation waveform uses CH1 channel as an example.

If you need to set **CH2 channel**, please refer to **CH1 channel** specific operation.

## Amplitude Modulation(AM)

The output modulation waveform consists of a carrier wave and a modulated wave. The carrier wave can be a sine wave, a square wave, a ramp wave, or an arbitrary wave. In amplitude modulation, the amplitude of the carrier varies with the instantaneous voltage of the modulation waveform. The user interface for amplitude modulation is shown below.



Figure 5-11: Amplitude modulation user interface

### How to set the parameters of amplitude modulation

- (1) After pressing the **Mod** function key, press the **Modulation type** soft key, use the knob to select, the modulation type is **AM**, press the **OK** soft key.
- (2) Press **~** to display the waveform and parameters of the current carrier. You can change the parameters of the carrier. For details, please refer to “Output Sine Wave” in P9. Press **~** or **Mod** to return to the modulation mode interface.
- (3) Press **Source** to select the source. If **External** is selected, the external signal source is connected to the **Ext Mod In** interface on the rear panel, and the

setting is completed; if you select **Internal**, continue with the following steps.

- (4) Press **Modulation Waveform** to select the modulation waveform. You can select **Sine**, **Square**, **Ramp**, **Noise**, or **Arb**.
- (5) Press the **AM frequency** button to set the AM frequency. The amplitude modulation range is from 2 mHz to 100 kHz (for internal sources only).
- (6) Press **Modulation Depth** to set the modulation depth. The modulation depth ranges from 0% to 100%.

#### Glossary

**AM frequency:** the frequency of the modulation waveform.

**Modulation Depth:** The range of amplitude variations of the output modulation waveform. At 0% modulation, the output amplitude is half of the set amplitude. At 100% modulation, the output amplitude is equal to the specified value. For external sources, the AM depth is controlled by the signal level on the **Ext Mod In** connector. +1 V corresponds to the currently selected depth of 100%.

## Frequency Modulation (FM)

The output modulation waveform consists of a carrier wave and a modulated wave. The carrier wave can be a sine wave, a square wave, a ramp wave, or an arbitrary wave. In frequency modulation, the frequency of the carrier varies with the instantaneous voltage of the modulation waveform. The user interface for frequency modulation is shown below.

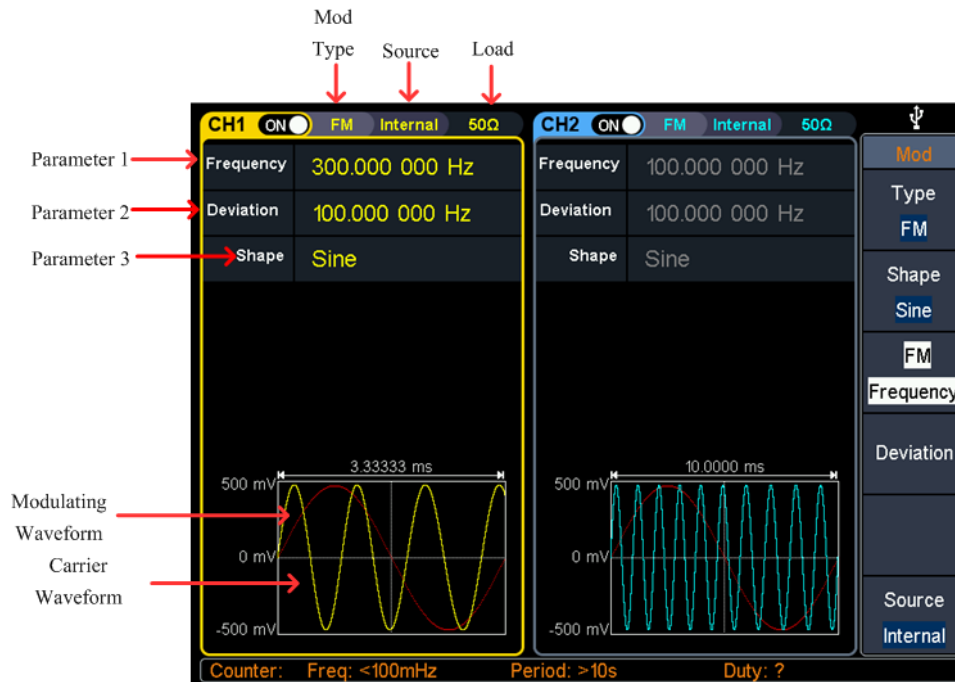



Figure 5-12: frequency modulation user interface

### Steps to set the frequency modulation

- (1) After pressing the **Mod** function key, press the **Modulation type** soft key, select the knob to select, the modulation type is **FM**, press the **OK** soft key.
- (2) Press  to display the waveform and parameters of the current carrier. You can change the parameters of the carrier. For details, please refer to “Output Sine Wave” in P9. Press  or **Mod** to return to the modulation mode interface.
- (3) Press **Source** to select the source. If External is selected, connect the external signal source to the **Ext Mod In** interface on the rear panel and skip to step (5). If you select Internal, continue with the following steps.
- (4) Press **Modulation Waveform** to select the modulation waveform type. You can select Sine, Square, Ramp, Noise, or Arb.
- (5) Press **Modulation Frequency** to set the modulation frequency value. The modulation frequency ranges from 2 mHz to 100 kHz (for internal sources only).
- (6) Press the **Frequency Offset** softkey to set the frequency offset value. Frequency offset range:  $2 \text{ mHz} \leq \text{offset} \leq \text{min}$  (min is the carrier frequency or maximum carrier frequency - carrier frequency) by default, the smaller of the two.

## Phase Modulation (PM)

The output modulation waveform consists of a carrier wave and a modulated wave. The carrier wave can be a sine wave, a square wave, a ramp wave, or an arbitrary wave. In phase modulation, the phase of the carrier varies with the instantaneous voltage of the modulation waveform. The phase modulation user interface is shown below

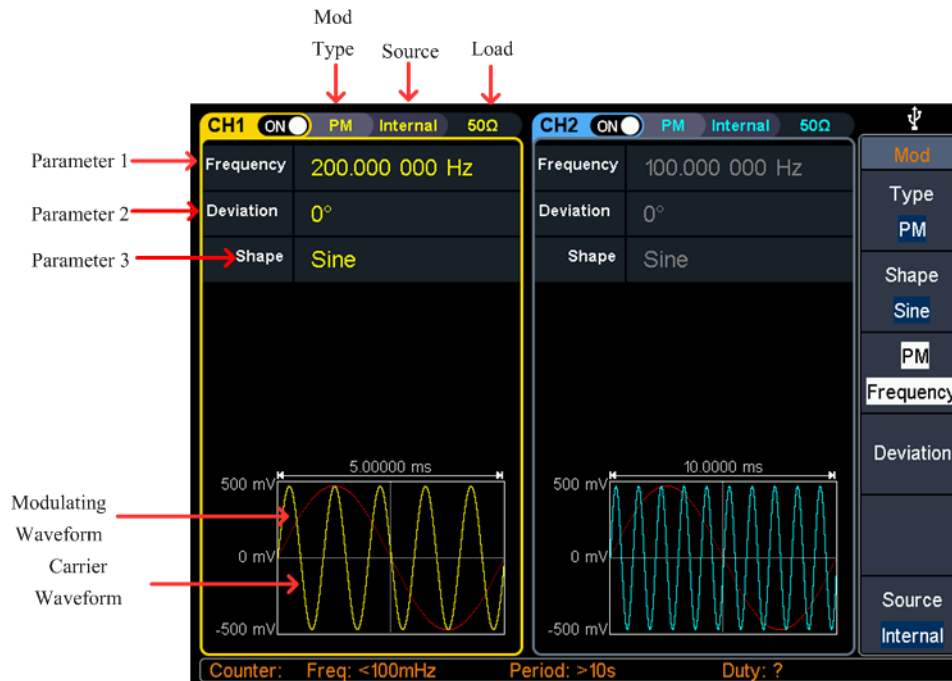



Figure 5-13: Phase modulation user interface

### Steps to set phase modulation

- (1) After pressing the **Mod** function key, press the **Modulation type** soft key, use the knob to select, the modulation type **PM**, and press the **OK** soft key.
- (2) Press  to display the waveform and parameters of the current carrier. You can change the parameters of the carrier. For details, please refer to “Output Sine Wave” in P9. Press  or **Mod** to return to the modulation mode interface.
- (3) Press **Source** to select the source. If **External** is selected, connect the external signal source to the **Ext Mod In** interface on the rear panel and skip to step (5). If you select **Internal**, continue with the following steps.
- (4) Press **Modulation Waveform** to select the modulation waveform. You can select **Sine**, **Square**, **Ramp**, **Noise**, or **Arb**.

- (5) Press the **Phase Modulation Frequency** softkey to set the phase modulation frequency. The range is from 2 mHz to 100 kHz (for internal sources only).
- (6) Press **Phase Deviation** to set the phase deviation, which is the offset of the phase, ranging from 0° to 180°.

### Pulse Width Modulation (PWM)

The output modulation waveform consists of a carrier wave and a modulated wave. The pulse width modulation function can only be applied to the modulated pulse wave, so the carrier can only be a pulse wave. In pulse width modulation, the pulse width of a carrier (pulse wave) varies with the instantaneous voltage of the modulation waveform.

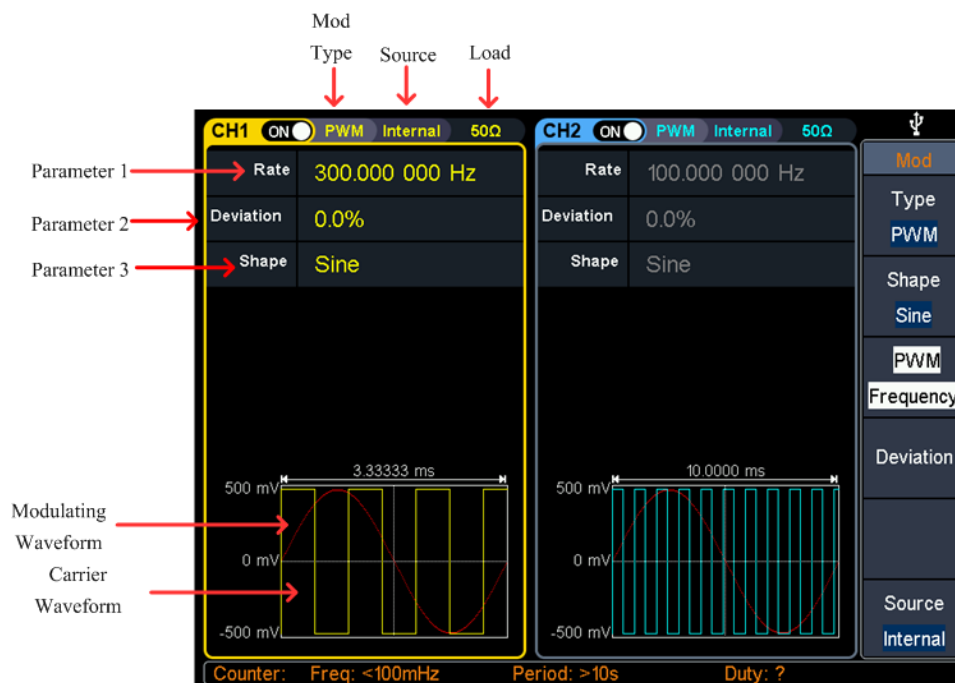

Figure 5-14 Pulse width modulation user interface

### Steps to set pulse width modulation

- (1) First set the carrier to a pulse wave, press **Mod** to enter PWM modulation mode.
- (2) After pressing the **Mod** function button, press the **Modulation Type** softkey, use the knob to select the modulation type as PWM and press the Enter soft key.
- (3) Press **⏏** to display the waveform and parameters of the current carrier. You can change the parameters of the carrier. For details, please refer to "Output Sine Wave" in **P9**. Press **⏏** or **Mod** to return to the modulation mode interface.

- (4) Press **Source** to select the source. If **External** is selected, connect the external signal source to the Ext Mod In interface on the rear panel and skip to step (6). If you select **Internal**, continue with the following steps.
- (5) Press **Modulation Waveform** to select the modulation waveform. You can select Sine, Square, Ramp, Noise, or Arb.
- (6) Press the **PWM Rate** softkey to set the **PWM rate**, which can be set from 2 mHz to 100 kHz (for internal sources only).
- (7) Press the **Duty Cycle** Deviation softkey to set the **duty cycle deviation** (depending on the non-modulation mode, the pulse wave setting menu is pulse width or duty cycle). The maximum value of the duty cycle deviation is 0 to 99%. [pulse wave duty ratio, 100% - pulse wave duty ratio]

## Amplitude shift keying (ASK)

The output modulation waveform consists of a carrier wave and a modulated wave. The carrier wave can be a sine wave, a square wave, a ramp wave, or an arbitrary wave. In phase modulation, the phase of the carrier varies with the instantaneous voltage of the modulation waveform. The user interface for phase modulation is shown below.

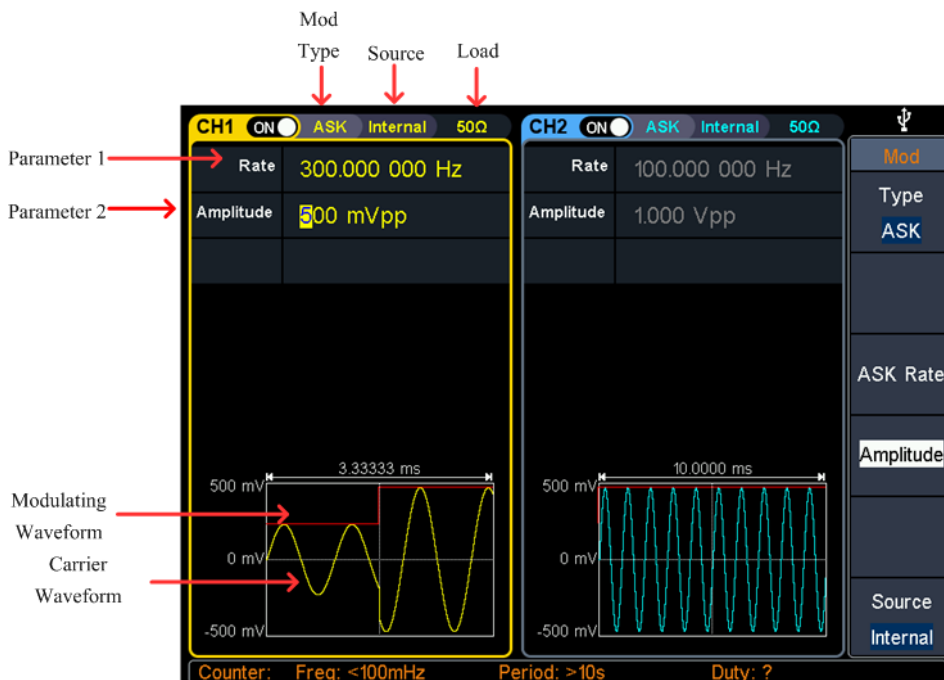



Figure 5-15 Amplitude shift keying user interface

## Steps to set frequency shift keying modulation

- (1) After pressing the **Mod** function key, press the **Modulation type** soft key, use the knob to select, the modulation type is ASK, press the Enter soft key.
- (2) Press  to display the waveform and parameters of the current carrier. You can change the parameters of the carrier. For details, please refer to "Output Sine Wave" in P9. Press  or **Mod** to return to the modulation mode interface.
- (3) Press **Source** to select the source. If **external** is selected, connect the external signal source to the Ext Trig/Burst/Fsk In interface on the rear panel and skip to step (5). If you select **internal**, continue with the following steps.
- (4) Note: When the source selects **external**, the slope is set to "positive," then the larger of the carrier amplitude and modulation amplitude is output when the logic is high level, and the carrier amplitude and modulation amplitude are output when the logic low level is input — the smaller one. When the slope is "negative," the opposite is true.
- (5) Press the **ASK Rate** softkey to set the **ASK rate**, which can be set from 2 mHz to 1 MHz (for internal sources only).
- (6) Press the **Amplitude** softkey to set the **amplitude**, i.e. the modulation amplitude, which can be set from 0 mVpp to 1 Vpp.



## Phase Shift Keying (PSK)

The output modulation waveform consists of a carrier wave and a modulated wave. The carrier wave can be a sine wave, a square wave, a ramp wave, or an arbitrary wave. In phase modulation, the phase of the carrier varies with the instantaneous voltage of the modulation waveform. The phase modulation user interface is shown below

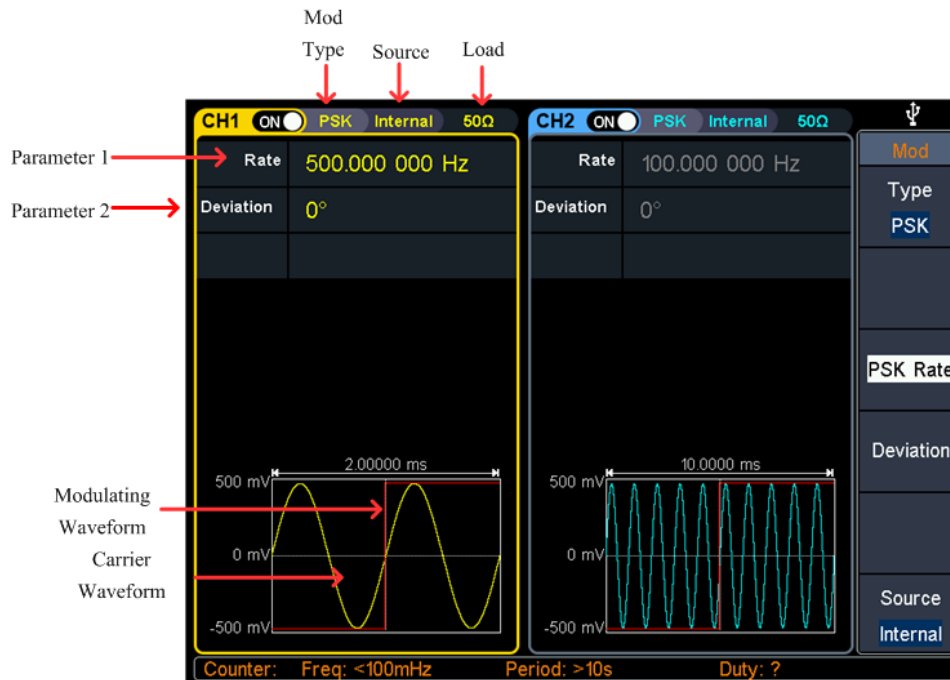

Figure 5-16 Phase shift keying user interface

### Steps to set phase shift keying modulation

- (1) After pressing the **Mod** function key, press the **Modulation type** soft key, use the knob to select, the modulation type is **PSK**, press the **Enter** soft key. The carrier waveform can be selected as needed. The following is a sine wave.
- (2) Press **⏏** to display the waveform and parameters of the current carrier. You can change the parameters of the carrier. For details, please refer to “Output Sine Wave” in P9. Press **⏏** or **Mod** to return to the modulation mode interface.
- (3) Press **Source** to select the source. If **external** is selected, connect the external signal source to the Ext Trig/Burst/Fsk In interface on the rear panel and skip to step (5). If you select **internal**, continue with the following steps.  
Note: When the source selects external, set the slope to “positive,” then output the carrier phase when input logic low level, and output the modulation phase

when input logic high level. When the slope is "negative," the opposite is true.

- (4) Press the **PSK** softkey to set the **PSK rate**, which can be set from 2 mHz to 1 MHz (for internal sources only).
- (5) Press Phase Deviation to set the phase deviation. The range is from 0° to 360°. The default is 0°.

## Frequency Shift Keying (FSK)

Using frequency shift keying modulation, the output frequency is shifted between two preset frequency values (carrier frequency and hopping frequency). The frequency at which the output moves between the two frequencies is determined by the internal frequency generator (internal source) or the signal level (external source) on the rear panel **Ext Trig/Burst/Fsk In** interface. The carrier wave can be a sine wave, a square wave, a ramp wave, or an arbitrary wave. The user interface of the frequency shift keying modulation is shown below.

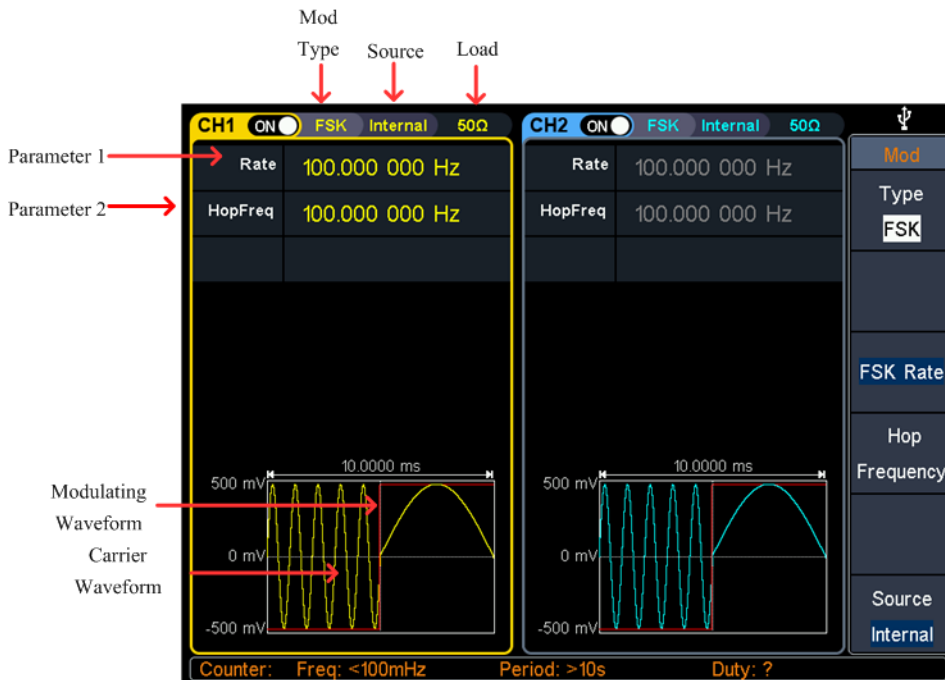



Figure 5-17: Frequency shift keying user interface

### Steps to set frequency shift keying modulation

- (1) After pressing the **Mod** function key, press the Modulation type soft key, use the knob to select, the modulation type is **PSK**, press the **OK** soft key. The carrier waveform can be selected as needed. The following is a sine wave.
- (2) Press  to display the waveform and parameters of the current carrier. You can change the parameters of the carrier. For details, please refer to "Output Sine Wave" in P9. Press  or **Mod** to return to the modulation mode interface.
- (3) Press **Source** to select the source. If **external** is selected, connect the external signal source to the **Ext Trig/Burst/Fsk In** interface on the rear panel and skip to step (5). If you select **internal**, continue with the following steps.

Note: When the source selects **external**, set the slope to "positive," then

output the carrier frequency when input logic low level, and output the frequency hopping frequency when input logic high level. When the slope is "negative," the opposite is true.

- (4) Press the **FSK Rate** softkey to set the **FSK rate**, which can be set from 2 mHz to 1 MHz (for internal sources only).
- (5) Press the **Frequency Hopping** softkey to set the **frequency hopping**, which is the alternating frequency.

## Hexadecimal frequency shift keying (3FSK)

Using ternary frequency shift keying modulation, the output frequency is shifted between three preset frequency values ("carrier frequency" and 2 "hopping frequencies"). The frequency at which this output moves between three frequencies is determined by the internal frequency generator (internal source). The carrier wave can be a sine wave, a square wave, a ramp wave, or an arbitrary wave. The user interface of ternary frequency shift keying modulation is shown in the figure below.

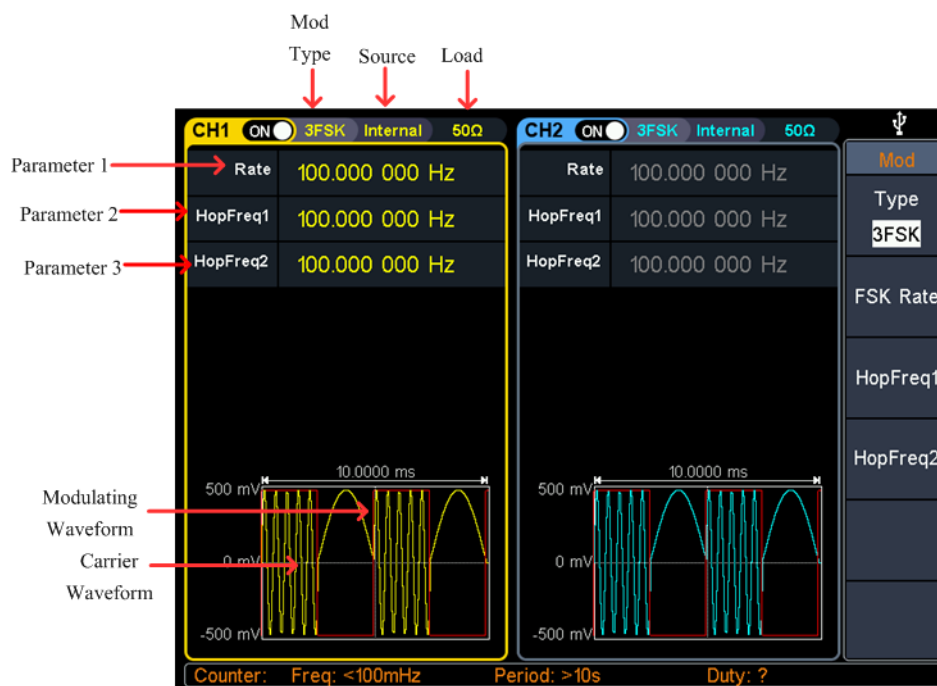



Figure 5-18 Hexadecimal frequency shift keying user interface

## Steps to set frequency shift keying modulation

- (1) After pressing the **Mod** function key, press the **modulation type** soft key, use the knob to select, the modulation type is **3FSK**, press the **enter** key. The carrier waveform can be selected as needed. The following is a sine wave.



- (1) After pressing the **Mod** function key, press the **modulation type** soft key, use the knob to select, the modulation type is **4FSK**, press the **enter** key. The carrier waveform can be selected as needed. The following is a sine wave.
- (2) Press  to display the waveform and parameters of the current carrier. You can change the parameters of the carrier. For details, please refer to "Output Sine Wave" in P9. Press  or **Mod** to return to the modulation mode interface.
- (3) Press **FSK Rate** to set the 4FSK rate from 2 MHz to 1 MHz.
- (4) Press **Frequency Hopping 1** **Frequency Hopping 2** **Frequency Hopping 3** Soft Key to select the setting frequency hopping, which is the alternating frequency.

## Binary phase shift keying (BPSK)

The use of binary phase shift keying modulation shifts the output phase between preset frequency values ("carrier phase" and "modulation phase"). The frequency at which the output moves between the two phases is determined by the internal frequency generator (internal source). The carrier wave can be a sine wave, a square wave, a ramp wave, or an arbitrary wave. The user interface of the two-phase phase shift keying modulation is shown in the figure below.

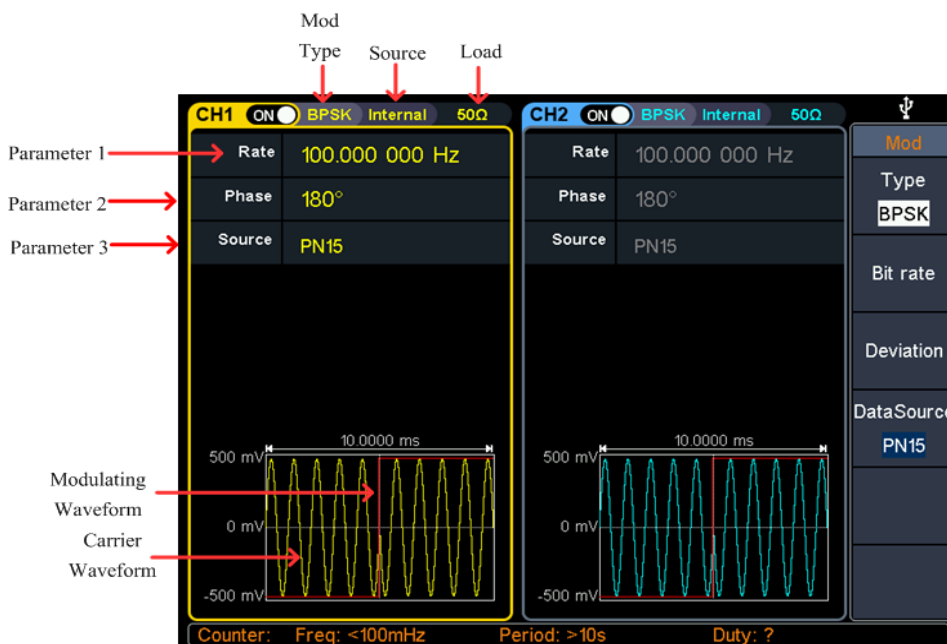



Figure 5-20 Binary phase shift keying user interface

## Steps to set frequency shift keying modulation

- (1) After pressing the **Mod** function key, press the **modulation type** soft key, use the knob to select the modulation type as **BPSK** and press the **ENTER** key. The carrier waveform can be selected as needed. The following is a sine wave.
- (2) Press  to display the waveform and parameters of the current carrier. You can change the parameters of the carrier. For details, please refer to "Output Sine Wave" in P9. Press  or **Mod** to return to the modulation mode interface.
- (3) Press **Code Rate** to set the code rate. The range is from 2 mHz to 1 MHz.
- (4) Press **Phase Deviation** to select the phase deviation. The range is from 0° to 360°.
- (5) Press **Data Source** to select the setting data source, including (01 code, 10 code, PN15 code, PN21 code).

## Oscillating keying (OSK)

The output modulation waveform consists of a carrier wave and a modulated wave. The carrier can only be a sine wave. In phase modulation, the phase of the carrier varies with the keying frequency of the modulated waveform. The user interface for the oscillating keying modulation is shown below.

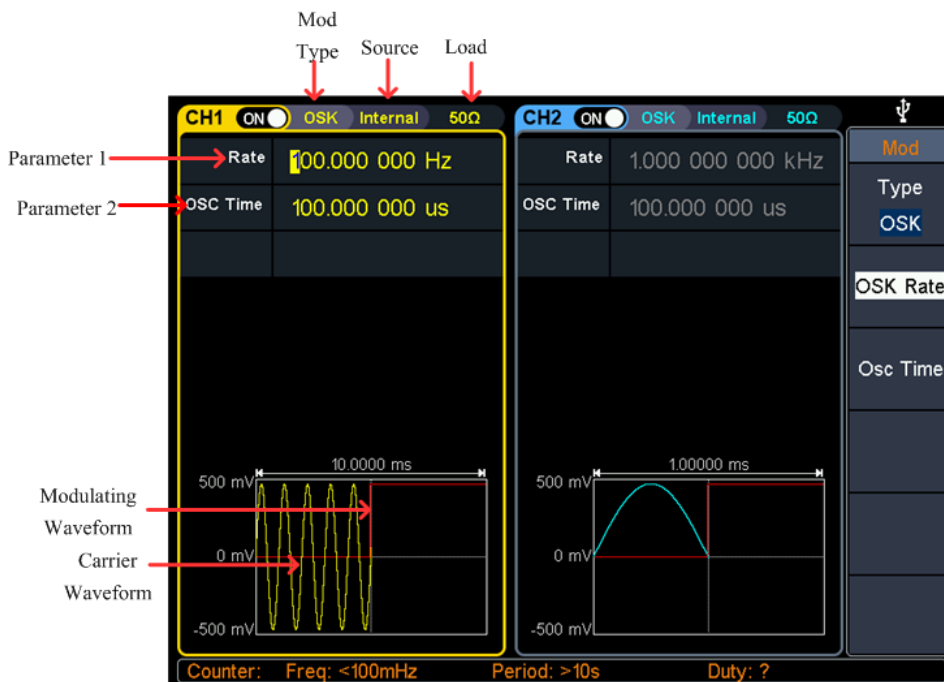



Figure 5-21 Oscillating keying user interface

## Steps to set frequency shift keying modulation

- (1) After pressing the **Mod** function key, press the **Modulation type** soft key, use the knob to select the modulation type as **OSK**, and press the **enter** key. The carrier waveform can be selected as needed. The following is a sine wave.
- (2) Press  to display the waveform and parameters of the current carrier. You can change the parameters of the carrier. For details, please refer to "Output Sine Wave" in P9. Press  or **Mod** to return to the modulation mode interface.
- (3) Press the **key frequency**. The soft key sets the **key rate**. The range is from 2 mHz to 1 MHz.
- (4) Press **Vibration Time** to select the **vibration time**, ranging from 8ns to 499.75 $\mu$ s.



## Output the sweep frequency (Sweep)

In the sweep mode, the frequency is output from the start frequency to the end frequency according to the sweep type change frequency within the specified sweep time. Sweeping can only be performed using sine, square, ramp or arbitrary waves.

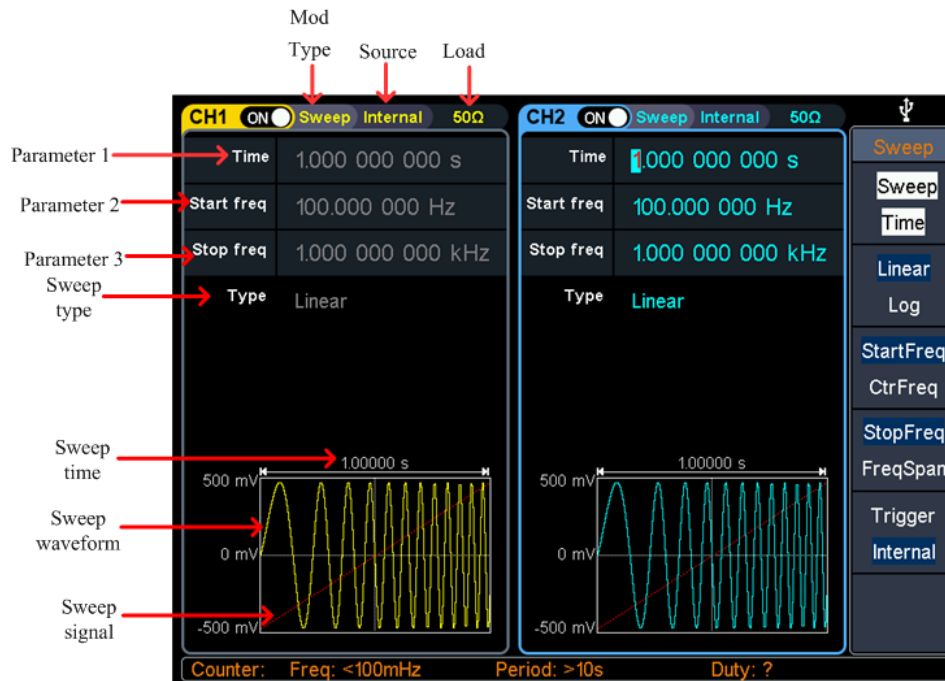







Figure 5-22: Sweep mode user interface

### Steps to set the scan mode

- (1) In the sine wave, square wave, ramp wave or arbitrary wave interface, press the **Sweep** function key to enter the scan mode.
- (2) Press , ,  or  to select the sweep waveform. For example, when selecting a sine wave, press  to display the scan waveform and parameters, and change the parameters. For details, please refer to “Output Sine Wave” of P9.
- (3) Press **Sweep Time** to set the scan time, which is the number of seconds from the start frequency to the stop frequency. The range is from 1ms to 500s.
- (4) Press the Linear **Sweep/Logarithmic Scan** softkey to switch the scan type. When the linear sweep is selected, the output frequency changes linearly during the scan; when the logarithmic sweep is selected, the logarithm of the output frequency changes during the scan.

- (5) Press the **Start Frequency / Center Frequency** softkey to select the start frequency or center frequency and set the corresponding value, as shown in Figure 1.
- (6) Press the **End Frequency/Frequency Range** softkey to select the end frequency or frequency range and set the corresponding value. See Figure 1 for details.

Wave type	Sine	Square	Ramp	Arbitrary
Parameter				
Minimum start/stop frequency	1uHz			
Maximum start/stop frequency	200MHz	50MHz	5MHz	15MHz (Bulid-in waves) 50MHz(User customized waves)

Table 1

- (7) Press the **Trigger Source** softkey to select the trigger source. The internal is the internal signal source; the external is the external source of the Ext Trig/Burst/Fsk In interface on the rear panel. Under the external signal source, the slope can be selected as positive/negative. (Positive: Select to output the trigger signal when rising. ; negative: select to output the trigger signal when falling); manually select manual trigger, each time you press the front panel knob in the sweep interface, it will start a scan.

## Output the burst (Burst)

Press **Burst** function key that is **burst**, to generate burst waveform output of various waveform functions. The burst can last for a specific number of waveform cycles (N-cycle bursts) or be controlled by an external gate signal (gated burst). Sine, square, ramp, pulse, or arbitrary wave functions can be used (this function is not available for noise waves and harmonics).

### Glossary

#### **Burst:**

The set of pulses transmitted together is called a "burst." The various signal generators are commonly referred to as the BURST function.

#### **N cycle burst:**

Contains a specific number of waveform cycles, each of which is initiated by a trigger event.

#### **Gated burst:**

Use external department signals to control when waveform burst waveforms are active

## Set N cycle burst

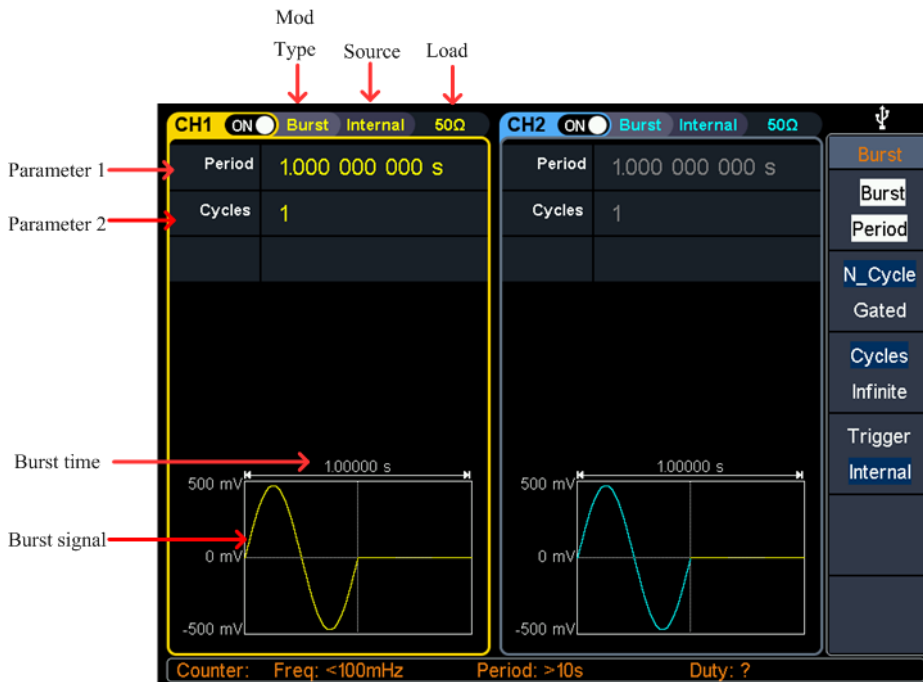









Figure 5-23: N cycle burst user interface

(1) In the sine wave, rectangular wave, ramp wave, pulse wave or arbitrary waveform interface, press the **Burst** function key to **burst**.

(2) Press , , ,  or  to select the waveform function. For example, when selecting a sine wave, press  to display the waveform and parameters, and change the parameters. For details, please refer to “Output Sine Wave of P9” and then press  to return to the burst mode interface.

**Note:** Before configuring the waveform parameters, you must first select the channel you want to configure. Press CH1 or CH2 to select the corresponding channel and the corresponding channel area in the user interface will light up.

(3) Press the **N Cycle/Gate** softkey to switch to the N cycle.

(4) Press the Trigger Period softkey to set the burst period, which can be set from 10 ns to 500 s (Min = Cycles \* Period).

(5) Press the **Cycles/Infinite** softkey to set the number of cycles, which is the number of waveform cycles to be output for each N-cycle pulse train. The range is from 1 to 50,000 cycles. When Infinite is selected, a continuous

waveform is an output until a trigger event is received.

**Note:** In **Burst** mode, the upper limit of the carrier frequency is half of the maximum frequency of the original carrier. Taking a sine wave as an example, the maximum carrier frequency is 200MHz. Press  to set the carrier to 200MHz. Then press the **Burst** softkey menu, then press or Burst to display the original carrier frequency to 100MHz.

### Warning:







- If necessary, the burst period will increase to accommodate the specified number of cycles.
- For infinite count bursts, an external or manual trigger source start pulse train (except internally) is required.

(6) Press **Source** to select the source. The **internal** is the internal signal source; the external is the external source of the **Ext Trig/Burst/Fsk In** interface on the rear panel. Under the **external** signal source, the **slope** can be selected as positive/negative. (Positive: Select the trigger signal when rising) ; negative: select to output the trigger signal when falling); manually select **manual** trigger, in the N cycle burst interface, press the **Trigger** under the current channel of the front panel to output a burst.

## Set the gated burst



Figure 5-24: gated burst user interface

- (1) In the sine wave, square wave, ramp wave, pulse wave or arbitrary waveform interface, press the **Burst** function key.
- (2) Press , , ,  or  to select the waveform function. For example, when selecting a sine wave, press  to display the waveform and parameters, and change the parameters. For details, please refer to the output sine wave of P9.  
**Note:** Before configuring the waveform parameters, you must first select the channel you want to configure. Press **CH1** or **CH2** to select the corresponding channel and the corresponding channel area in the user interface will light up.
- (3) Press the **N Cycle/Gate** softkey to switch to the gate.
- (4) Press the **Polarity** softkey to select the gate signal "Positive" or "Negative." The default is positive. The gate polarity is only available in gated burst mode. The instrument outputs a pulse train when the gate signal on the [Ext Trig/Burst/Fsk In] connector on the rear panel is "High" or "Low."

## Counter

The frequency meter measures signals in the frequency range from 100 mHz to 200 MHz. The **[10MHz In/Out/Counter]** connector on the rear panel is used by default to receive the frequency meter input signal. The frequency meter works from the start unless the connector is set to an external clock input or clock output.

- (1) Press the front panel **Counter** function key to enter the frequency meter interface.
- (2) Connect the signal to be tested to the **[10MHz In/Out/Counter]** connector on the rear panel.
- (3) Set the counter:
  - Press the **Coupling** soft key to switch AC or DC to set the coupling mode of the input signal.
  - Press the **Sensitivity** softkey to toggle low, medium or high.  
For small amplitude signals, the sensitivity is selected to be medium or high.

For low frequency large signals or signals with slow rising edges, low sensitivity is selected, and the measurement results are more accurate.

- Press the **HF Suppression** softkey to toggle ON or OFF high frequency rejection.

High-frequency rejection can be used to filter high-frequency components when measuring low-frequency signals, improving measurement accuracy.

When measuring low frequency signals with a frequency less than 1 kHz, turn on high frequency rejection to filter out high frequency noise interference; turn off high frequency rejection when measuring high frequency signals with frequencies greater than 1 kHz.

- Press the **Trigger Level** softkey. Turn the **knob** to change the current cursor position value, press the arrow keys to move the cursor left or right; or use the **numeric keypad** to enter a value and then select the desired unit from the right menu. The trigger level ranges from -2.5 V to 2.5 V.

After the setting is completed, the frequency meter will measure the signal to be tested at the current setting. If the reading is unstable, repeat the above adjustment until the display is stable.

- (4) The frequency, period, duty cycle, positive pulse width, and negative pulse width can be viewed on the frequency meter interface

## Utility function setting

Press the **Utility** function key to enter the system options menu. The user can set the display parameters of the signal generator, CH1/2 settings, interface settings, and system parameters. Press **Utility** again to exit the system options menu.

## Display Setting

### Brightness Control

- (1) Press the **Utility** softkey, select **Display Settings**, and press the **Backlight** softkey to select **Backlight**.
- (2) Turn the **knob** to change the current cursor position value, press the **←/→** arrow key to move the cursor left or right, or use the **numeric keypad** to enter the brightness percentage. The brightness range is from 0% to 100%.

## Screen Saver

If there is no operation during the set screen saver time, the screen enters the protection mode (the screen display is turned off, that is, the black screen). Press any key to redisplay the operation interface.

- (1) Press the **Utility** softkey, select **Display Settings**, and press the **Screen Saver** softkey to select the **On/Off** screen saver.
- (2) When the screen saver is turned on, the screen saver time can be set. Turn the **knob** to change the current cursor position value, press the **←/→** arrow key to move the cursor left or right, or use the **numeric keypad** to enter the time in minutes, and the screen saver time range is 1 to 999 minutes.

## Separator

The user can set the separator of the screen display data.

- (1) Press the **Utility** softkey, select **Display Settings**, and press the **Delimiter** softkey.
- (2) Press the **Separator** softkey to toggle between commas, spaces, and none.

Taking the frequency parameter as an example:

Comma	Separator: 1.000,000,0
Space	Separator: 1.000 000 0
None	Separator: 1.0000000

## Date

- (1) Press the **Utility** softkey, select **Display Settings**, and then press the **Date** softkey to select Date.
- (2) Turn the **knob** to change the current cursor position value, press the **←/→** arrow key to move the cursor left or right.

## CH1/2 Settings

### Synchronize

Our instruments can output basic waveforms (except noise), arbitrary waveforms (except DC), harmonics, sweep waveforms, burst waveforms, and synchronized waveforms of modulated waveforms from a single channel or simultaneously from

two channels. This signal is output from the front panel **[Sync]** connector.

### (1) Sync Switch

Enable or disable the sync signal on the [Sync] connector. Press **Utility** to set **CH1 sync/CH2 sync** and select "On" or "Off" sync signal output. The default is "on", which sends the sync signal to the [Sync] connector. The output level on the [Sync] connector is a logic low when the sync signal is turned off.

### (2) Synchronization signal of various waveforms

- For sine, square, ramp and pulse waves, the sync signal is a square wave with a 50% duty cycle. When the waveform output is positive, the sync signal is TTL high concerning the 0V voltage (or DC offset value). When the waveform output is negative, the sync signal is TTL low relative to the 0V voltage (or DC offset value).
- For an arbitrary waveform, the sync signal is a square wave with a variable duty cycle. When the output waveform amplitude reaches a certain value, the sync signal is TTL high.
- For harmonics, the sync signal is referenced to the harmonic order and is a square wave with a variable duty cycle. When the output waveform amplitude is positive, the sync signal is TTL high.
- For AM, FM, PM, and PWM, for internal modulation, the sync signal is referenced to the modulation frequency, and the sync signal is a square wave with a 50% duty cycle. In the first half of the modulation waveform, the sync signal is TTL high. When external modulation is performed, there is no sync signal output.
- For ASK, FSK, PSK, BPSK, QPSK, 3FSK, 4FSK, the synchronization signal is referenced to the keying frequency, and the synchronization signal is a square wave with a duty cycle of 50%. For ASK, FSK, PSK, there is no sync signal output during external modulation.
- For OSK, the sync signal is referenced to the keyed frequency and the sync signal is a square wave with a 50% duty cycle. When the internal crystal oscillator starts, the sync signal is TTL high. When external modulation is performed, there is no sync signal output.
- For N-cycle bursts, the sync signal is TTL high at the beginning of the burst. At the end of the specified number of cycles, the sync signal is TTL low (if the waveform has an associated start phase, it may not be a zero crossing). For an infinite count pulse train, the sync signal is the same as the sync signal of the continuous waveform.
- For externally gated bursts, the sync signal follows its gate signal. Note: This signal does not become TTL low until the end of the last cycle (if the waveform has an associated starting phase, it may not be a zero crossing).

## Output Setting

### Set the load

For each of the two channels of the front panel, the signal generator has a fixed series output impedance of 50  $\Omega$ . If the actual load impedance is different from the



specified value, the displayed amplitude and offset level will not match the voltage level of the part under test. The load impedance settings provided are only for the convenience of the user to match the display voltage to the desired load.

**The step to set the CH1 or CH2 load value is as follows:**

- (1) Press the **Utility** function button to select the CH1/2 setting. Press **CH1 Load** to select CH1 load, or press **CH2 Load** to select CH2 load; press again to switch to high impedance or \*ohm ("\*" represents a value).
- (2) To change the resistance value, after selecting \*ohm in the previous step, turn the **knob** to change the current cursor position value, press the **←/→** arrow key to move the cursor left or right, or use the **numeric keypad** to input the value. The input load range is from 1 ohm to 10k ohm.

---

**Warning:**

Each output of the front panel has a fixed 50 Ω series output impedance, regardless of the value specified for this parameter. If the actual load is different from the specified value, the displayed voltage level does not match the actual level.

---

## Interface Setting

- (1) Press the **Utility** function key, select the **interface setting**, and press the **USB device** soft key to switch the USB device.
  - Set the communication protocol type of the USB Device interface on the rear panel.
  - **PC:** This is the internal communication protocol. Select this option when connecting to the ultrawave host computer software via the USB Device interface.
  - **USBTMC:** Select this when you need to use the USBTMC communication protocol standard.
- (2) Press the **Network Settings** button and select Network Settings to go to the next level menu: IP Address, Gateway, Subnet Mask, Port. The physical address displayed on the interface cannot be modified. After setting the network parameters such as the IP address of the user-defined signal generator, you need to wait for 2S or more to restart the machine.
  - Press **IP Address** to select the **IP address**. Use the numeric keypad and the rotary keys to enter the desired IP address. The format of the IP address is

nnn.nnn.nnn.nnn. The first nnn ranges from 1 to 223 (except 127), and the other three nnn ranges from 0 to 255. It is recommended to ask your network administrator for an available IP address.

- Press **Gateway** and select **Gateway**. Use the numeric keypad and knob keys to enter the desired gateway address. The default gateway format is nnn.nnn.nnn.nnn. The first nnn ranges from 1 to 223 (except 127), and the other three nnn ranges from 0 to 255. It is recommended to consult your network administrator for an available IP address.
- Press the **Subnet Mask** softkey to select the **subnet mask**. Use the numeric keypad and knob keys to enter the desired subnet mask address. The default gateway format is nnn.nnn.nnn.nnn where nnn ranges from 0 to 255. It is recommended to ask your network administrator for an available IP address.
- Press **Port** to select the port. Use the numeric keypad and knob keys to enter the desired port value, which ranges from 0001 to 4000.

## System Setting

### Select the language

Press the **Utility** function key to select **System Settings** and press the **Language** softkey to switch the display language.

### Buzzer

Press the **Utility** function button, select **System Settings**, and press the **beep** soft key to select the “on” or “off” buzzer.

### Clock source

An internal clock source is provided, an external clock source from the [10MHz In/Out/Counter] input on the rear panel is also accepted, and a clock source can be output from the [Ref Clk Out] connector for use by other devices.

---

### Warning:

**The amplitude of the [10MHz In/Out/Counter] input signal must be above 1 V.**

---

Press the **Utility** function key, select **System Settings**, press the **Clock Source** softkey to select the clock source and then press the soft key to switch. Internal/External

**Warning:**

The clock source defaults to the internal clock source. When an external clock source is required, this function is switched to the outside. At this time, the clock source forcibly outputs the output. When the clock source output selection is turned on, the clock source must be switched to internal, and the frequency meter function stops after the clock output is turned on.

## Clock Output

Press the **Utility** function key, select **System Settings**, select the **Clock Output** soft key, press the Clock Output menu, and then press the soft key to toggle on/off.

## Firmware update

Press the **Utility** softkey to select **System Setup**.

Plug the USB storage device into the USB connector on the front panel of the instrument. (Note: If the USB storage device is not plugged in, the **Firmware Upgrade** menu will be disabled)

Select the **Firmware Upgrade** softkey, press the **firmware upgrade** menu, use the front panel knob to select USBDEVICE, press to enter the softkey, and enter the USB storage device to browse the file.

Use the front panel knob to select the downloaded firmware file and press the Execute softkey to perform the firmware upgrade.

Note: The firmware file name is as follows: xxx model \_Vx.x.x version.upp.

Note: If the firmware update fails, an error code will be displayed on the screen. The error message corresponding to the error code can be found in Schedule 2.

Error Code	Error Information
2	File too large
3	Error reading firmware file
4	Verify firmware file error
5	Firmware type flag error
6	Instrument version cannot be upgraded to firmware file version
7	Instrument model does not match the firmware file model

Table 2

## Restore to factory setting

Press the **Preset** function key, press the **reset** soft key, and then press the **Enter** to

restore the instrument's settings to the factory default values (Note: "Reset Settings" menu is "Factory Settings" to press the "Reset" soft key for factory setting. ). The factory default parameter values are as follows

<b>Output Configuration</b>	<b>Factory Setting</b>
CH1 signal output switch	OFF
CH2 signal output switch	OFF
Function	Sine
Frequency	1 kHz
Amplitude/offset	1 Vpp / 0 Vdc

<b>Waveform Configuration</b>	<b>Factory Setting</b>
Frequency	1.000kHz
Period	1.000ms
Amplitude	1.000Vpp
Offset	0.000V
High Level	500mV
Low Level	-500mV
Start Phase	0deg
Symmetry	50%
Pulse Width	500.000us
Duty Cycle	50.00%
Rising Time	1.953125us
Falling Time	1.953125us
Build-in Wave	X <sup>2</sup>
Harmonic Wave Type	Even harmonic
Harmonic Wave Times	2
Number	2
Harmonic Wave Amplitude	1.000Vpp
Harmonic Wave Phase	0deg

<b>Modulation Waveform</b>	<b>Factory Setting</b>
Modulation type	AM
Modulated waveform	Sine
Amplitude modulation	100.000Hz

frequency	
Modulation depth	100%
Source	Internal
Frequency modulation frequency	100.000Hz
Frequency offset	100.000Hz
Phase modulation frequency	100.000Hz
Phase deviation	0deg
PWM rate	100.000Hz
Duty cycle deviation	0.0%
ASK rate	100.000Hz
ASK amplitude	1.000Vpp
PSK rate	100.000Hz
PSK phase deviation	0deg
FSK rate	100.000Hz
Frequency hopping	100.000Hz
Frequency hopping 1	100.000Hz
Frequency hopping 2	100.000Hz
Frequency hopping 3	100.000Hz
Code rate	100.000Hz
BPSK phase deviation	180deg
Data source	PN15 code
Key frequency	100.000Hz
Vibration time	100.000us

<b>Sweep</b>	<b>Factory Setting</b>
Sweeping time	1.000s
Sweeping method	Linear Sweep
Starting frequency	100.000Hz
Termination frequency	1.000kHz
Center frequency	550.000Hz
Frequency range	900.000Hz
Trigger source	Internal
Slope	Positive

<b>Burst</b>	<b>Factory Setting</b>
Trigger interval	1.000s
Burst mode	N cycle
Number of cycles	1
Trigger source	Internal
Slope	Positive
Polarity	Positive

<b>Counter</b>	<b>Factory Setting</b>
Coupling	AC
Sensitivity	Low
High frequency suppression	ON
Trigger level	0.000V

<b>Edit</b>	<b>Factory Setting</b>
Number of waveform points	1000
Interpolation	Off
Template	Blank

<b>Save/recall instrument settings</b>	<b>Factory Setting</b>
Reset settings	Factory setting
Power-on setting	Last time setting
user settings	Setup0

Accessibility	Factory Setting
Backlight	100%
Screen saver	turn on
Screen saver time	30Minute
Separator	Space
CH1 synchronization	shut down
CH2 synchronization	shut down
CH1 load	50ohm
CH2 load	50ohm
USB device	USBTMC
IP address	192.168.1.99
Gateway	192.168.1.1
Subnet mask	255.255.255.000
Port	3000
Language	Subject to the actual machine
Buzzer	turn on
Clock source	internal

Between Channels	Factory Setting
Frequency lock	Off
Amplitude lock	Off

## Edit the Arbitrary Wave (Edit)

Press the front panel **Edit** function key to enter the arbitrary wave editing interface.

- (1) **Set the number of waveform points:** Press the **number of waveform points** softkey, use the **knob** to change the value directly or use the **numeric keypad** to input and select the unit softkey. The number of points ranges from 2 to 100,000.
- (2) **Set interpolation:** Press the **Interpolate** softkey to toggle the interpolation **on/off**. Select **On** to connect each waveform point with a straight line; select **Off**, the voltage level between each waveform point remains the same, creating a waveform similar to the step.

**(3) Select a template:** Press the **Template** softkey to select blank, sine, square, ramp, and noise.

**(4) Edit Waveform Point:** Press to **edit the waveform point** to enter the Edit Waveform Point menu.

- Select the **number of points** and enter the number of the point you want to set.
  - Select the **voltage** and enter the voltage value to be set at this point.
  - Repeat this step to set all the points you want to set.
  - Press **Store** to enter the file system interface.
  - If you want to save the waveform to the built-in memory, check INTER and press to **enter** the softkey. Turn the knob to select one of the USER files (EditMemory cannot be selected) and press the **Save** softkey. (The file size is displayed on the right side of the USER file. If 0B is displayed, it means the file is empty.)
- ◆ **Description:** EditMemory is a temporary data space created, saved, edited or recalled by any arbitrary wave. Saving the waveform is to save the data of this space to the user-specified location (EditMemory is in the memory and never empty). The data in this space is changed after an arbitrary waveform is called, a new waveform is created, or a related programming command is received.

If you want to save to a USB storage device, you need to plug the USB storage device into the front panel USB interface. Turn the knob to select USBDEVICE. Press to **enter** the softkey and the instrument will list the directories of the folders and files in the USB storage device. You can turn the knob to select a folder or file. Press to **enter** the softkey to enter the currently selected folder. To return to the parent directory, press the **Back** soft key.

After selecting the storage path, press the **Save As** softkey and the input keyboard appears on the screen. Turn the knob to select a character. Press the **uppercase/lowercase** softkey to toggle the case of keyboard characters. Press the **Select** soft key to enter the current character. Press the Delete soft key to delete the last character that has been entered. Press the **Finish** soft key to finish editing, and the waveform will be saved in the current path with the file suffixed by bin.

## File system (Store)

File system memory is divided into the internal memory (INTER) and removable memory (USBDEVICE). When a USB device is connected, the main interface displays INTER and USBDEVICE. If no USB device is connected, only the internal memory INTER is displayed. The internal memory can store 32 arbitrary waveform data.

Press the front panel **Store** function key to enter the file system.



## Save Current Arbitrary Wave

- (1) Press the  button to enter the Arbitrary Wave menu and configure the waveform parameters.
- (2) Press the front panel **Store** function key to enter the file system.
  - If you want to save the current arbitrary waveform to the built-in memory, select INTER and press to **enter** the soft key. Turn the knob to select one of the USER files (EditMemory cannot be selected) and press the **Save** softkey. (The file size is displayed on the right side of the USER file. If 0B is displayed, it means the file is empty.)

**Description:** EditMemory is a temporary data space created, saved, edited or recalled by any arbitrary wave. Saving the waveform is to save the data of this space to the user-specified location (EditMemory is in the memory and never empty). The data in this space is changed after an arbitrary waveform is called, a new waveform is created, or a related programming command is received.

- If you want to save to a USB storage device, you need to plug the USB storage device into the front panel USB interface. Turn the knob to select USBDEVICE. Press to **enter** the softkey and the instrument will list the directories of the folders and files in the USB storage device. You can turn the knob to select a folder or file. Press to **enter** the softkey to enter the currently selected folder. To return to the parent directory, press the **Back** soft key.

After selecting the storage path, press the Save As softkey and the input keyboard appears on the screen. Turn the knob to select a character. Press the uppercase/lowercase softkey to toggle the case of keyboard characters. Press the Select soft key to enter the current character. Press the Delete soft key to delete the last character that has been entered. Press the Finish soft key to finish editing, and the waveform will be saved in the current path in a file format such as a bin.

## Bring up arbitrary wave files in internal/external memory

Press the front panel **Store** function key to enter the file system.

- To call up the waveform file in the internal memory, select INTER under the memory selection interface and press to **enter** the soft key. Turn the knob to select a file and press to call up the softkey. If the reading is successful, the screen will prompt “File Read Successful.”

**Note:** The file size is displayed on the right side of the file. If 0B is displayed, the file is empty.

- To recall the waveform file in the USB storage device, turn the knob to select USBDEVICE in the memory selection interface. Press to enter the softkey and the instrument will list the directories of the folders and files in the USB storage device. Turn the knob to select a folder or file. Select the file with the suffix of bin and press to call up the softkey. If the reading is successful, the screen will prompt “File Read Successful.” Press the ‘Save As’ soft key; a soft keyboard will appear on the screen interface. We can use the front panel knob to rotate left or right or the right menu soft key to create and name files.

**Note:** The screen will output the waveform file <500kB, which can be directly previewed in the lower right corner of the screen. If the knob is named, press the knob once to confirm it. If you press and hold the button (greater than 2s), the button will be saved when it is popped up. The current screen interface in bmp format to the u disk specific path ((model) / IMAGE / xx.bmp).

- Copy the waveform file from the USB storage device to the internal memory: After the waveform file in the USB storage device is called up according to the previous step, press the Back soft key to return to the upper directory. After returning to the memory selection interface, turn the knob to select INTER and press to enter the soft key. Turn the knob to select a USER file and press the Save button to copy the waveform file to the internal memory.

**Note:**In the arbitrary waveform interface, Shape displays the storage location or waveform name of the current arbitrary waveform. USER indicates the internal memory, External indicates the USB storage device, and if it is a built-in waveform, the built-in waveform name is displayed.

## Clear waveform from memory

- (1) Press the front panel **Store** function key to enter the file system.
- (2) Select INTER under the memory selection interface and press to **enter** the soft key. Press the **Security** soft key, the screen pops up, and then press the **OK** soft key to clear all waveforms in the internal memory.

## Save/recall instrument settings (Preset)

The instrument settings can be saved as files in internal memory or on an external USB storage device. Up to 16 instrument settings can be saved in the instrument's internal memory. To save more settings, use a USB storage device. The settings file saved to the USB storage device uses the extension CFG. The saved settings can be restored from files in the internal memory or USB storage device.

### Operation Steps:

Press the front panel **Preset** function key to enter the preset menu, and press the **Save/Read Settings** soft key to enter the memory selection interface.

- If you want to save the settings to the built-in memory, check **INTER** and press the **Enter** soft key. Turn the knob to select a Setup file and press the **Save** softkey. (The file size is displayed on the right side of the Setup file. If 0B is displayed, it means the file is empty.)

Note: Press the **Security** softkey and press the **OK** soft key to clear all settings in the internal memory.

- If you want to save to a USB storage device, you need to plug the USB storage device into the front panel USB interface. Turn the knob to select **USBDEVICE**. Press to **enter** the softkey and the instrument will list the directories of the folders and files in the USB storage device. You can turn the knob to select a folder or file. Press to enter the softkey to **enter** the currently selected folder. To return to the parent directory, press the **Back** soft key.

After selecting the storage path, press the **Save As** softkey and the input keyboard appears on the screen. Turn the knob to select a character. Press the **uppercase/lowercase** softkey to toggle the case of keyboard characters. Press the **Select** soft key to enter the current character. Press the **Delete** soft key to delete the last character that has been entered. Press the **Finish** soft key to complete the editing. The current instrument settings will be saved in the current path in the cfg file format.

- To recall the settings, select the desired file and press to **call up** the softkey.

## Use build-in help (Help)

(1) To get help for any front panel buttons or menu softkeys, first press the front panel **Help** softkey, then press the button you need help with.

(2) Press the **Help** softkey again to exit the help interface.

## 6. Communicate with PC

Supports communication with a computer via a USB interface or a LAN interface. Using the ultrawave host computer software installed on the computer, the signal generator can be operated on the computer to control the output of the signal generator.

Here's how to connect to a computer. First, install the ultrawave communication software on the CD-ROM on your computer. Then, there are several connection options to choose from.

### Use USB interface

Set the USB device protocol type of the signal generator: Press Utility → Interface Settings → USB Device to switch to PC.

Connection: Connect the USB Device interface on the rear panel of the signal generator to the USB interface of the computer with a USB cable.

Install the driver: When the signal generator is turned on, the computer will pop up the [Found New Hardware Wizard] dialog box, please follow the wizard prompts to install the driver. The path of the driver is the USBDRV folder in the directory where the ultrawave communication software is located.

“C:\Program Files\BNC\ultrawave\USBDRV”。

Host computer communication port setting: Open the ultrawave software of the host computer, click “Transfer” in the menu bar, select “Port Settings,” in the setting dialog box, select the communication port as “USB.” After the connection is successful, the connection status prompt in the lower right corner of the software interface turns green.

### Using a LAN interface

#### direct connection

Connection. Plug one end of the network cable into the LAN connector on the rear panel of the signal generator; the other end is plugged into the LAN interface of the computer.

Set the network parameters of your computer. Since the signal generator does not support automatic IP address acquisition, you need to specify the IP yourself. Here we set the IP address to 192.168.1.71.

Set the network parameters of the host computer. Run the PC software on the computer. In the "Transport" menu, under "Port Settings," select the communication port as "LAN," the IP is set to be the same as the first three fields of the computer's network IP in step (2), and the last field has a different IP address. It is "192.168.1.99"; the port can be set to any value from 0 to 4000. However, since ports below 2000 are often occupied, it is recommended to set it to 2000 or higher. Here, it is set to "3000".

**Figure 5 1: Host software setting**

Set the network parameters of the signal generator. In the signal generator, press the Utility function key, select Interface Settings, and select the Network Settings softkey to enter the submenu. Set the IP address and port to the IP and port in the PC software port settings in step (3). After the shutdown and restart, if the data can be obtained normally in the PC software, the connection is successful.

Through the router connection. Connect the LAN interface on the rear panel of the signal generator to the router with a network cable. The computer is also connected to the router.

Set the network parameters of your computer. Since the signal generator does not support automatic IP address acquisition, you need to specify the IP yourself. The default gateway and subnet mask settings must match the settings of the router. For example, the IP address is set to 192.168.1.71, the subnet mask is set to 255.255.255.0, and the default gateway is set to 192.168.1.1.

Set the network parameters of the host computer. Run the PC software on the computer. In the "Transport" menu, under "Port Settings," select the communication port as "LAN," the IP is set to be the same as the first three fields of the computer's network IP in step (2), and the last field has a different IP address. It is "192.168.1.99"; the port can be set to any value from 0 to 4000. However, since ports below 2000 are often occupied, it is recommended to set it to 2000 or higher. Here, it is set to "3000".

**Figure 5 2: Set the host network parameter**

Set the network parameters of the signal generator. In the signal generator, press the Utility function key, select Interface Settings, and select the Network Settings softkey to enter the submenu. Set the IP address and port to the IP and port in the PC software port settings in step (3). The gateway settings need to be the same as the gateway settings of the router. After the shutdown and restart, if the data can be obtained normally in the PC software, the connection is successful.

For details of SCPI, please see the Signal Generator SCPI Instruction Set.

For the specific operation of ultrawave software, please press F1 to view the built-in help documentation.

## 7. Troubleshooting

### 1. If the instrument is still black and there is no display when you press the power switch, please follow the steps below:

- Check if the power connector is connected.
- Check that the voltage selector is in the correct gear position.
- Check that the fuse at the power connector meets the specified type and rating and is blown (can be opened with a flat-blade screwdriver).
- After completing the above checks, restart the instrument.
- If you still cannot use this product, please contact BNC and let us serve you.

### 2. The measured value of the output signal amplitude does not match the displayed value:

Check that the actual load value of the signal is consistent with the load value set by the system. For details, please refer to P43.

"Set the load value."

If you encounter other problems, please try resetting the settings (see "Clock Source" on P45) or reboot. If you still cannot use this product, please contact BNC and let us serve you.

## 8. Specification

All specifications apply to this product unless otherwise stated. The signal generator must be operated continuously for more than 30 minutes at the specified operating temperature to meet these specifications.

In addition to the specifications marked with the word "Typical," the specifications used are guaranteed.

Waveform	
Standard Waveform	Sine wave, square wave, ramp wave, pulse wave, noise, arbitrary wave, harmonic
Arbitrary waveform	Sinc, exponential rise, exponential decline, electrocardiogram, Gaussian, semi-positive, Lorentz, dual audio, DC voltage totaling more than 150 kinds
Sampling Rate	1.25GSa/s
Number of channels	2
Number of digits	14bits

Frequency Feature		
Frequency resolution: 1 $\mu$ Hz or 10 significant figures;		
Frequency stability: $\pm 1$ ppm at 0-40C;		
Frequency aging rate: $\pm 1$ ppm per year.		
Sine wave	A2255	1 $\mu$ Hz—250 MHz
	A2085	1 $\mu$ Hz—80 MHz
Square wave	A2255	1 $\mu$ Hz—50 MHz
	A2085	1 $\mu$ Hz—30 MHz
Ramp wave	1 $\mu$ Hz—5 MHz	
Pulse wave	1 $\mu$ Hz—25 MHz	
Noise wave	120 MHz bandwidth (-3 dB) (Gaussian white noise)	
Arbitrary wave	1 $\mu$ Hz—15MHz (Built-in waves); 1 $\mu$ Hz—50MHz(User customized waves)	
Harmonic wave	A2255	1 $\mu$ Hz—250 MHz

	A2085	1 $\mu$ Hz—80 MHz
--	-------	-------------------

**Amplitude characteristics (not specifically labeled, the load defaults to 50 $\Omega$ )**

Output amplitude	High Resistance	2mVpp ~ 20Vpp ( $\leq 40$ MHz) 2mVpp ~ 10Vpp ( $\leq 80$ MHz) 2mVpp ~ 5Vpp ( $\leq 120$ MHz) 2mVpp ~ 2Vpp ( $\leq 200$ MHz)
	50 $\Omega$	1mVpp ~ 10Vpp ( $\leq 40$ MHz) 1mVpp ~ 5Vpp ( $\leq 80$ MHz) 1mVpp ~ 2.5Vpp ( $\leq 120$ MHz) 1mVpp ~ 1Vpp ( $\leq 200$ MHz)
Amplitude accuracy	$\pm$ (1% of setting + 1 mVpp) (Typical value 1kHz sine, 0V offset)	
Amplitude resolution	1 mVpp or 4 digits	
DC offset range (High resistance, open circuit)	$\pm$ (10 Vpk – Amplitude Vpp/2)	
DC offset range	$\pm$ (5 Vpk – Amplitude Vpp/2)	
DC offset accuracy	$\pm$ (1 % of  setting  + 1 mV + amplitude Vpp * 0.5%)	
Offset resolution	1 mV or 4 digits	
Output Impedance	50 $\Omega$ (typical)	

**Waveform Feature**
**Sine**

Bandwidth flatness (1 Vpp, relative to 1KHz)	$\leq 10$ MHz: $\pm 0.2$ dB $\leq 60$ MHz: $\pm 0.3$ dB $\leq 100$ MHz: $\pm 0.5$ dB $\leq 160$ MHz: $\pm 1$ dB $\leq 200$ MHz: $\pm 1.5$ dB
Harmonic distortion	Typical (0dBm) DC to 1MHz: $< -65$ dBc 1MHz to 10MHz: $< -60$ dBc 10MHz to 120MHz: $< -50$ dBc 120MHz to 200MHz: $< -45$ dBc
Total harmonic distortion	$< 0.05$ %, 10 Hz to 20 kHz, 1 Vpp
Non-harmonic distortion	Typical (0dBm) $\leq 10$ MHz: $< -70$ dBc $> 10$ MHz: $< -70$ dBc + 6dB/ sound interval
Phase noise	Typical (0dBm, 10kHz offset) 10MHz: $\leq -110$ dBc/Hz

**Square**

Rise/fall time	$< 5$ ns
----------------	----------



Jitter	300ps + 100ppm
Overshoot	< 3%
Duty cycle	50.0% (fixed)
<b>Ramp</b>	
Linearity	< 0.1% of peak output (typical 1 kHz, 1 Vpp, symmetry 50%)
Symmetry	0% to 100%
<b>pulse</b>	
Pulse Width	12 ns to 1000 ks
Duty cycle	0.3%~99.7%
Rise and fall time	$\geq 7$ ns
Overshoot	< 3%
Jitter	300ps + 100ppm
<b>Noise</b>	
Types	Gaussian white noise
Bandwidth (-3db)	120M
<b>Arbitratry wave</b>	
Bandwidth	120m
Waveform length	2 ~ 1M points
Sampling rate	< = 312m (at frequency <25khz)
Amplitude accuracy	1.25g (at frequency $\geq 25$ khz)
Minimum rise and fall time	14 bits
Jitter	< 7 ns
<b>Harmonic wave</b>	
Harmonic number	$\leq 16$
Frequency Range	1 $\mu$ Hz ~ 100MHz
Harmonic type	Odd, even, sequential, custom
Harmonic amplitude	Each harmonic amplitude can be set
Harmonic phase	Each harmonic phase can be set

**Modulated Waves****AM**

Carrier	Sine wave, square wave, ramp wave, arbitrary wave
Modulated signal source	Internal or external
Internal modulation waveform	Sine wave, square wave, ramp wave, white noise, arbitrary waveform
Internal amplitude modulation frequency	2 mHz to 100 kHz
Depth	0.0% to 100.0%

**FM**

Carrier	Sine wave, square wave, ramp wave, arbitrary wave
Modulated signal source	Internal or external
Internal modulation waveform	Sine, square, ramp, white noise, and arbitrary waveforms
Internal modulation frequency	2 mHz to 100 kHz
Frequency offset	$2 \text{ mHz} \leq \text{offset} \leq \min(\text{carrier frequency, carrier maximum frequency} - \text{carrier frequency})$ by default, the smaller of the two
<b>PM</b>	
Carrier	Sine wave, square wave, ramp wave, arbitrary wave
Modulated signal source	Internal or external
Internal modulation waveform	Sine, square, ramp, white noise, and arbitrary waveforms
The internal phase modulation frequency	2 mHz to 100 kHz
Phase deviation range	$0^\circ \sim 180^\circ$
<b>PWM</b>	
Carrier	Pulse wave
Modulated signal source	Internal or external
Internal modulation waveform	Sine, square, ramp, white noise, and arbitrary waveforms
The internal phase modulation frequency	2 mHz to 100 kHz
Offset	$0 \sim \min(\text{min is the smaller value of pulse wave duty cycle and } 100\% \text{-pulse wave duty cycle})$
<b>FSK</b>	
Carrier	Sine wave, square wave, ramp wave, arbitrary wave
Modulated signal source	internal
Internal modulation waveform	50% square wave
FSK frequency	2 mHz ~ 1MHz
<b>3FSK</b>	
Carrier	Sine wave, square wave, ramp wave, arbitrary wave
Modulated signal source	internal
Internal modulation waveform	50% square wave
FSK frequency	2 mHz ~ 1MHz

<b>4FSK</b>	
Carrier	Sine wave, square wave, ramp wave, arbitrary wave
Modulated signal source	internal
Internal modulation waveform	50% square wave
<b>PSK</b>	
Carrier	Sine wave, square wave, ramp wave, arbitrary wave
Modulated signal source	Internal or external
Internal modulation waveform	50% square wave
PSK frequency	2 mHz ~ 1MHz
<b>ASK</b>	
Carrier	Sine wave, square wave, ramp wave, arbitrary wave
Modulated signal source	Internal or external
Internal modulation waveform	50% square wave
ASK frequency	2 mHz ~ 1MHz
<b>BPSK</b>	
Carrier	Sine wave, square wave, ramp wave, arbitrary wave
Modulated signal source	internal
Internal modulation waveform	50% square wave
BPSK frequency	2 mHz ~ 1MHz
<b>OSK</b>	
Carrier	Sine wave
Modulated signal source	internal
Internal modulation waveform	50% square wave
Oscillation time	8ns to 499.75 $\mu$ s
OSK frequency	2 mHz ~ 1MHz
<b>Sweep</b>	
Carrier	Sine, rectangular wave, ramp wave, arbitrary wave
Minimum/maximum starting frequency	1uHz

Maximum/termination frequency	Sine wave: 200MHz Square wave: 50MHz Ramp wave: 5MHz Arbitrary wave: 15MHz (built-in waveform) or 50MHz (user-defined waveform)
Types	Linear, logarithmic
Sweep direction	Up / Down
Sweep time	1 ms to 500 s $\pm$ 0.1%
Trigger source	Internal, external, manual
<b>Burst</b>	
Waveform	Sine wave, square wave, ramp wave, pulse wave, and arbitrary wave
Types	Count (1 to 50,000 cycles), unlimited, gated
Trigger source	Internal, external, manual
Carrier frequency	2mHz to 100MHz
Internal cycle	10 ns to 500 s (Min = Cycles * Period)
Gate source	External trigger

### Counter Specification

Measurement function	Frequency, period, positive pulse width, negative pulse width, duty cycle	
Frequency Range	Single channel: 100 mHz ~ 200 MHz	
Frequency resolution	7 digits	
Coupling method	AC, DC	
Voltage range and sensitivity (non-modulated signal)		
DC coupling	DC offset range	$\pm 1.5$ V
	100 mHz ~ 100 MHz	250 mVp-p - 5 Vp-p (AC+DC)
	100 MHz ~ 200 MHz	400 mVp-p - 5 Vp-p (AC+DC)
AC coupling	1 Hz ~ 100 MHz	250 mVp-p - 5 Vp-p
	100 MHz ~ 200 MHz	400 mVp-p - 5 Vp-p
The pulse width and duty cycle measurement	1 Hz ~ 10 MHz (100 mVpp ~ 5 Vpp)	
Input resistance	1 M $\Omega$	
Sensitivity	Can set high, medium and low three files	
Trigger level range	$\pm 2.5$ V	
Channel coupling	1 Hz ~ 10 MHz (100 mVpp ~ 5 Vpp)	
Amplitude lock, frequency lock, channel copy		

### Input/Output

Communication Interface	USB Host, USB Device, LAN
<b>External modulation input</b>	
Input frequency range	DC-20 kHz

Input level range	$\pm 1$ V full scale
Input resistance	10 k $\Omega$ typical value
<b>External trigger input</b>	
Level	TTL-compatible
Slope	Rise/fall optional
Pulse Width	>100 ns
<b>The external clock input (frequency meter input)</b>	
External clock input (frequency meter input) impedance	1M $\Omega$ DC coupled
Input level range	100 mVp-p to 3.3 Vp-p
Lock time	<1s
Lock range	10 MHz $\pm$ 9 kHz
<b>External clock output</b>	
Frequency	10 MHz
Impedance	50 $\Omega$ , DC coupling
Amplitude	1.6Vpp 50 $\Omega$ impedance
<b>Sync Output</b>	
Level	TTL-compatible
Maximum frequency	1MHz

**Display:**

Feature	Description
Display type	8-inch color LCD
display resolution	800 horizontal $\times$ 600 vertical pixels
Display color	A208536 colors, 16 bits, TFT

**Power:**

Feature	Description
Voltage	100 - 240 VAC, 50/60 Hz, CAT II
Power consumption	Less than 50 W
Fuse	250 V, F2AL
Start time	Booting for 30 mins

**Environment:**

Feature	Description
Temperature	Working temperature: 0 $^{\circ}$ C $\sim$ 40 $^{\circ}$ C Storage temperature: -20 $^{\circ}$ C $\sim$ 60 $^{\circ}$ C
Relative humidity	$\leq$ 90%
Height	Operating 3,000 meters Non-operation 12,000 meters
Cooling method	Smart fan cooling

**Mechanical Specification:**

<b>Feature</b>	<b>Description</b>
Dimension	340 mm (Length) × 177 mm (Height) × 90mm (Width)
Weight	2.5 Kg

**Adjustment interval:**

The recommended calibration interval is one year.

## 9. Appendix

### Appendix A: Accessories

- A power cord that meets the standards of the country where you are located
- A USB communication cable
- A communication software CD
- A Quick Guide
- One BNC/Q9 line

### Appendix B: Maintenance and cleaning

#### General maintenance

Do not store or place the instrument where the LCD monitor will be exposed to direct sunlight for long periods of time.

**Cautious:** Do not allow sprays, liquids, and solvents to get on the instrument to avoid damaging the instrument.

#### Cleaning

The instrument is often checked for usage. Follow the steps below to clean the outer surface of the instrument:

1. Wipe the dust on the outside of the instrument with a soft cloth. When cleaning the LCD screen, be careful not to scratch the transparent LCD screen.
2. Wipe the instrument with a soft cloth that is damp but not dripping. Please pay attention to disconnect the power supply. It can be scrubbed with a mild detergent or water. Do not use any abrasive chemical cleaners to avoid damaging the instrument.



**Warning:** Before re-energizing, please confirm that the instrument has dried out to avoid electrical short circuit or even personal injury due to moisture.

---